**Heat-treatable steels, alloy steels and
free-cutting steels —**

Part 2:
Alloy steels for quenching and tempering

*Aciers pour traitement thermique, aciers alliés et aciers pour
décolletage —*

Partie 2: Aciers alliés pour trempe et revenu



COPYRIGHT PROTECTED DOCUMENT

© ISO 2012

All rights reserved. Unless otherwise specified, no part of this publication may be reproduced or utilized in any form or by any means, electronic or mechanical, including photocopying and microfilm, without permission in writing from either ISO at the address below or ISO's member body in the country of the requester.

ISO copyright office
Case postale 56 • CH-1211 Geneva 20
Tel. + 41 22 749 01 11
Fax + 41 22 749 09 47
E-mail copyright@iso.org
Web www.iso.org

Published in Switzerland

Contents

Page

| | |
|--------------------------------------------------------------------------------------------------------------------------------------------------------|-----------|
| Foreword | iv |
| 1 Scope | 1 |
| 2 Normative references | 1 |
| 3 Terms and definitions | 2 |
| 4 Classification and designation | 3 |
| 4.1 Classification | 3 |
| 4.2 Designation | 3 |
| 5 Information to be supplied by the purchaser | 3 |
| 5.1 Mandatory information | 3 |
| 5.2 Options and/or supplementary or special requirements | 3 |
| 6 Manufacturing process | 4 |
| 6.1 General | 4 |
| 6.2 Deoxidation | 4 |
| 6.3 Heat-treatment condition and surface condition at delivery | 4 |
| 6.4 Traceability of the cast | 4 |
| 7 Requirements | 5 |
| 7.1 Chemical composition, mechanical properties and hardenability | 5 |
| 7.2 Machinability | 5 |
| 7.3 Cold shearability | 5 |
| 7.4 Grain size | 6 |
| 7.5 Non-metallic inclusions | 6 |
| 7.6 Internal soundness | 6 |
| 7.7 Surface quality | 6 |
| 7.8 Decarburization | 6 |
| 7.9 Shape, dimensions and tolerances | 7 |
| 8 Inspection | 7 |
| 8.1 Testing procedures and types of documents | 7 |
| 8.2 Frequency of testing | 7 |
| 8.3 Specific inspection and testing | 7 |
| 9 Test methods | 8 |
| 9.1 Chemical analysis | 8 |
| 9.2 Mechanical tests | 8 |
| 9.3 Hardness and hardenability tests | 8 |
| 9.4 Retests | 9 |
| 10 Marking | 9 |
| Annex A (normative) Ruling sections for mechanical properties | 34 |
| Annex B (normative) Supplementary or special requirements | 37 |
| Annex C (informative) Designation of steels given in this part of ISO 683 and of comparable grades covered in various designation systems | 39 |
| Annex D (informative) Dimensional standards applicable to products complying with this part of ISO 683 | 41 |
| Bibliography | 42 |

Foreword

ISO (the International Organization for Standardization) is a worldwide federation of national standards bodies (ISO member bodies). The work of preparing International Standards is normally carried out through ISO technical committees. Each member body interested in a subject for which a technical committee has been established has the right to be represented on that committee. International organizations, governmental and non-governmental, in liaison with ISO, also take part in the work. ISO collaborates closely with the International Electrotechnical Commission (IEC) on all matters of electrotechnical standardization.

International Standards are drafted in accordance with the rules given in the ISO/IEC Directives, Part 2.

The main task of technical committees is to prepare International Standards. Draft International Standards adopted by the technical committees are circulated to the member bodies for voting. Publication as an International Standard requires approval by at least 75 % of the member bodies casting a vote.

Attention is drawn to the possibility that some of the elements of this document may be the subject of patent rights. ISO shall not be held responsible for identifying any or all such patent rights.

ISO 683-2 was prepared by Technical Committee ISO/TC 17, *Steel*, Subcommittee SC 4, *Heat treatable and alloy steels*.

This first edition cancels and replaces the first edition of ISO 683-1:1987 and ISO/TR 11637:1997, which have been technically revised.

ISO 683 consists of the following parts, under the general title *Heat-treatable steels, alloy steels and free-cutting steels*:

- *Part 1: Non-alloy steels for quenching and tempering*
- *Part 2: Alloy steels for quenching and tempering*
- *Part 9: Wrought free-cutting steels*
- *Part 10: Wrought nitriding steels*
- *Part 11: Case-hardening steels*
- *Part 14: Hot-rolled steels for quenched and tempered springs*
- *Part 15: Valve steels for internal combustion engines*
- *Part 17: Ball and roller bearing steels*
- *Part 18: Bright products of unalloyed and low alloy steels*

Heat-treatable steels, alloy steels and free-cutting steels —

Part 2: Alloy steels for quenching and tempering

1 Scope

1.1 This part of ISO 683 specifies the technical delivery requirements for

- semi-finished products, hot formed, e.g. blooms, billets, slabs (see Note 1),
- bars (see Note 1),
- wire rod,
- finished flat products, and
- hammer or drop forgings (see Note 1)

manufactured from the direct hardening alloy steels and the alloy flame- and induction-hardening steels listed in Table 3 and supplied in one of the heat-treatment conditions given for the different types of products in Table 1 and in one of the surface conditions given in Table 2.

The steels are, in general, intended for the manufacture of quenched and tempered or austempered (see 3.2 and Note 2) and flame- or induction-hardened machine parts (see Tables 8 and 9).

The requirements for mechanical properties given in this part of ISO 683 are restricted to the sizes given in the relevant Table 8.

NOTE 1 Hammer-forged semi-finished products (blooms, billets, slabs, etc.), seamless rolled rings and hammer-forged bars are in the following covered under semi-finished products or bars and not under the term “hammer and drop forgings”.

NOTE 2 For the purposes of simplification, the term “quenched and tempered” is, unless otherwise indicated, used in the following also for the austempered condition.

NOTE 3 For International Standards relating to steels complying with the requirements for the chemical composition in Table 3, however, supplied in other product forms or treatment conditions than given above or intended for special applications, and for other related International Standards, see the Bibliography.

NOTE 4 This part of ISO 683 does not apply to bright products and bars and wire rod for cold heading. For such products, see ISO 683-18 and ISO 4954.

1.2 In special cases, variations in these technical delivery requirements or additions to them can form the subject of an agreement at the time of enquiry and order (see Annex B).

1.3 In addition to this part of ISO 683, the general technical delivery requirements of ISO 404 are applicable.

2 Normative references

The following referenced documents are indispensable for the application of this document. For dated references, only the edition cited applies. For undated references, the latest edition of the referenced document (including any amendments) applies.

ISO 148-1, *Metallic materials — Charpy pendulum impact test — Part 1: Test method*

ISO 683-2:2012(E)

ISO 377, *Steel and steel products — Location and preparation of samples and test pieces for mechanical testing*

ISO 404, *Steel and steel products — General technical delivery requirements*

ISO 642, *Steel — Hardenability test by end quenching (Jominy test)*

ISO 643, *Steels — Micrographic determination of the apparent grain size*

ISO 3887, *Steels — Determination of depth of decarburization*

ISO 4885, *Ferrous products — Heat treatments — Vocabulary*

ISO 4948-1, *Steels; Classification — Part 1: Classification of steels into unalloyed and alloy steels based on chemical composition*

ISO 4948-2, *Steels; Classification — Part 2: Classification of unalloyed and alloy steels according to main quality classes and main property or application characteristics*

ISO/TS 4949, *Steel names based on letter symbols*

ISO 4967, *Steel — Determination of content of non metallic inclusions — Micrographic method using standard diagrams.*

ISO 6506-1, *Metallic materials — Brinell hardness test — Part 1: Test method*

ISO 6508-1, *Metallic materials — Rockwell hardness test — Part 1: Test method (scales A, B, C, D, E, F, G, H, K, N, T)*

ISO 6892-1, *Metallic materials — Tensile testing — Part 1: Method of test at room temperature*

ISO 6929, *Steel products — Vocabulary*

ISO 7788, *Steel — Surface finish of hot-rolled plates and wide flats — Delivery requirements*

ISO 9443, *Heat-treatable and alloy steels — Surface quality classes for hot-rolled round bars and wire rods — Technical delivery conditions*

ISO/TR 9769, *Steel and Iron — Review of available methods of analysis*

ISO 10474, *Metallic products — Inspection documents*

ISO 14284, *Steel and iron — Sampling and preparation of samples for the determination of chemical composition*

3 Terms and definitions

For the purposes of this document, the definitions of ISO 377, ISO 4885, ISO 4948-1, ISO 4948-2, ISO 6929, ISO 14284 and the following apply.

NOTE For deviations from these terms and definitions, see Notes 1 and 2 to the Scope.

3.1 ruling section

section for which the specified mechanical properties shall apply

NOTE Independent of the actual shape and dimensions of the cross-section of the product, the size of its ruling section is always given by a diameter. This corresponds to the diameter of an “equivalent round bar”. That is, a round bar which, at the position of its cross-section specified for taking the test pieces for the mechanical tests, will, when being cooled from austenitizing temperature, shows the same cooling rate as the actual ruling section of the product concerned at its position for taking the test pieces.

3.2**austempering**

austenitization of a steel with a subsequent cooling to a temperature in the Bainite region and holding at this temperature until a desired degree of transformation is obtained

NOTE The subsequent cooling to room temperature can be carried out in any manner desired.

3.3**alloy steel**

non-alloy steel as defined in ISO 4948-1

3.4**special**

special steel as defined in ISO 4948-2

4 Classification and designation**4.1 Classification**

The classification of the relevant steel grades is according to ISO 4948-1 and ISO 4948-2. All steel grades covered by this part of ISO 683 are alloy special steels.

4.2 Designation

For the steel grades covered by this part of ISO 683, the steel names as given in the relevant tables are allocated in accordance with ISO/TS 4949.

5 Information to be supplied by the purchaser**5.1 Mandatory information**

The manufacturer shall obtain the following information from the purchaser at the time of enquiry and order:

- a) the quantity to be delivered;
- b) the designation of the product form (slab, bloom, billet, round bar, wire rod, wide flat, sheet, plate, strip, forging, etc.);
- c) either the designation of the dimensional standard and the dimensions and tolerances selected from this (see 7.9) or, for example in the case of drop forgings, the designation of the drawing or any other document covering the dimensions and tolerances required for the product;
- d) reference to this part of ISO 683, i.e. ISO 683-2;
- e) the designation of the steel grade given in Table 3;
- f) the symbol for the required heat-treatment condition (see Table 1, column 2);
- g) standard designation for a test report 2.2 or, if required any other type of inspection document in accordance with ISO 10474 or according to another regional standard, e.g. EN 10204 or JIS G 0415.

5.2 Options and/or supplementary or special requirements

A number of options are specified in this part of ISO 683 and listed below. If the purchaser does not indicate the wish to implement any of these options, the products will be supplied in accordance with the basic specifications of this part of ISO 683 (see 5.1):

- a) if another surface condition than "hot worked" or a special surface quality is required, the surface condition (see Table 2) and the surface quality (see 7.7);

ISO 683-2:2012(E)

- b) any requirement for the hardenability (+H, +HH, +HL) for special steels (see 7.1.4 and Tables 5 to 7);
- c) any supplementary requirement that shall be complied with, the symbol and, where necessary, the details of this supplementary requirement (see Annex B);
- d) any requirement for the verification of non-metallic inclusion content (see 7.5);
- e) verification of hardenability and, if agreed, the information about calculation of the hardenability (see 9.3.2);
- f) any requirement regarding the permissible depth of decarburization (see 7.8);
- g) suitability of bars and rod for bright drawing (see 7.7.4);
- h) any requirement relating to the removal of surface defects (see 7.7.5).

EXAMPLE 50 hot-rolled round bars according to ISO 1035-1 with a nominal diameter of 40 mm and a nominal length of 8 000 mm with diameter tolerance according to class S and with length tolerance according to class L2 of ISO 1035-4 made of steel grade ISO 683-2 42CrMo4 (see Table 3) in the heat-treatment condition +S (see Table 1), surface blast cleaned (+BC) (see Table 2), cast analysis/option B.5 with an inspection certificate 3.1 according to ISO 10474

50 round bars ISO 1035 - 40,0S × 8 000L2

ISO 683-2 - 42CrMo4+S +BC option B.5

ISO 10474 - 3.1

6 Manufacturing process

6.1 General

The manufacturing process of the steel and of the products is, with the restrictions given by the requirements in 6.2 to 6.4, left to the discretion of the manufacturer.

For minimum reduction ratio or minimum thickness deformation ratio of rolled and forged products, see B.5.

6.2 Deoxidation

All steels shall be deoxidized.

6.3 Heat-treatment condition and surface condition at delivery

6.3.1 Heat-treatment condition

The products shall be delivered in one of the heat-treatment conditions given in Table 1, lines 2 to 6 as agreed during time of enquiry and order.

6.3.2 Particular surface conditions

If so agreed at the time of enquiry and order, the products shall be delivered in one of the particular surface conditions given in Table 2, lines 3 to 6.

6.4 Traceability of the cast

Each product shall be traceable to the cast (see Clause 10).

7 Requirements

7.1 Chemical composition, mechanical properties and hardenability

7.1.1 General

Table 1 shows the combinations of usual heat-treatment conditions at delivery, product forms and requirements, as specified in Tables 3 to 9.

Except where steels are ordered in the quenched and tempered condition, this part of ISO 683 makes for the alloyed steels provisions to be supplied with or without hardenability requirements (see Table 1, columns 8 and 9).

7.1.2 Chemical composition

The chemical composition determined by cast analysis shall comply with the values in Table 3.

Permissible deviations between the limiting values for cast analysis and the values for product analysis are given in Table 4.

The product analysis shall be carried out when specified at the time of the enquiry and order (see B.4).

7.1.3 Mechanical properties

Where the steel is ordered without hardenability requirements, the requirements for mechanical properties specified in Tables 7 or 8 apply as appropriate for the particular heat treatment condition.

In this case, the hardenability values given in Table 5 are for guidance purposes only.

The mechanical property values given in Table 8 apply to test pieces in the quenched and tempered condition, which have been taken and prepared in accordance with Figure 2 or Figures 3 and 4 (see also footnote a to Table 1).

7.1.4 Hardenability

Where the steel is ordered using the designations given in Table 5 or 6 to normal (see Table 5) or to narrowed (see Table 6) hardenability requirements, the values of hardenability given in Table 5 or 6, respectively apply in addition to the requirements cited in Table 1, columns 9.1 and 9.2. (See footnote b to Table 3.)

7.1.5 Surface hardness

For the surface hardness of alloy steels after flame or induction hardening, the specifications in Table 9 apply.

7.2 Machinability

All steels are machinable in the condition "soft annealed". Where improved machinability is required, grades with a specified sulfur range and/or with a specific treatment should be ordered to improve machinability (see also Table 1, line 6).

7.3 Cold shearability

7.3.1 Under suitable shearing conditions (avoiding local stress peaks, preheating, application of blades with a profile adapted to that of the product, etc.) all steels are cold shearable in the soft annealed (+A) condition.

7.3.2 Steel grades 34Cr4, 37Cr4, 41Cr4, 25CrMo4, 34CrMo4, 42CrMo4 and 41CrNiMo2 with maximum and specified range S-content, boron-alloy steel grades 33MnCrB5-2 and 39MnCrB6-2 and the corresponding +H, +HH and +HL grades (see Tables 3 and 5 to 7) are, under suitable conditions, also cold shearable when being delivered in the condition "treated to improve shearability (+S)" with the hardness requirements given in Table 7.

7.3.3 Under suitable conditions, steel grades 20MnB5, 30MnB5, 39MnB5 and 27MnCrB5-2, and the corresponding grades with requirements on hardenability (see Table 5), are cold shearable in the untreated condition.

7.4 Grain size

All steels shall have a fine grain structure with an austenite grain size of 5 or finer when tested in accordance with ISO 643. For verification, see B.2.

7.5 Non-metallic inclusions

7.5.1 Microscopic inclusions

The special steels shall have a certain degree of cleanness; however, verification of the non-metallic inclusion content requires a special agreement. If there is such an agreement at the time of enquiry and order, the microscopic non-metallic inclusion content shall be determined to an agreed procedure and within agreed limits in accordance with ISO 4967 or another standard, e.g. regional standards EN 10247 or JIS G 0555.

For grades with specified minimum sulfur content, the agreement should not include sulfides.

7.5.2 Macroscopic inclusions

This requirement is applicable to the verification of the macroscopic inclusions in special steels. If verification is agreed, the method and acceptance limits shall be agreed at the time of enquiry and order.

7.6 Internal soundness

Where appropriate, requirements relating to the internal soundness of the products shall be agreed at the time of enquiry and order (see B.3).

7.7 Surface quality

7.7.1 All products shall have a smooth surface finish appropriate to the manufacturing process applied.

7.7.2 Minor surface imperfections, which may occur also under normal manufacturing conditions, such as prints originating from rolled-in scale, are not to be regarded as defects.

7.7.3 Bars and wire rod are delivered with surface class A according to ISO 9443 and hot-rolled plates and wide flats are delivered with a surface according ISO 7788 unless otherwise agreed at the time of enquiry and order.

Where no International Standard on the surface quality of steel products exists, detailed requirements referring to this characteristic shall, where appropriate, be agreed at the time of enquiry and order.

It is more difficult to detect and eliminate surface discontinuities from coiled products than from cut lengths. This should be taken into account when agreements on surface quality are made.

7.7.4 If suitability of bars and rod for bright drawing is required, this shall be agreed at the time of enquiry and order.

7.7.5 The removal of surface defects by welding shall only be permitted with the approval of the customer or his/her representative.

If surface discontinuities are repaired, the method and maximum depth of removal shall be agreed at the time of enquiry and order.

7.8 Decarburization

Requirements relating to the permissible depth of decarburization may be agreed at the time of enquiry and order.

The depth of decarburization shall be determined in accordance with the micrographic method specified in ISO 3887.

7.9 Shape, dimensions and tolerances

The shape, dimensions and tolerances of the products shall comply with the requirements agreed at the time of enquiry and order. The agreements shall, as far as possible, be based on corresponding International Standards (see Annex D); otherwise on suitable national standards.

8 Inspection

8.1 Testing procedures and types of documents

8.1.1 Products complying with this part of ISO 683 shall be ordered and delivered with one of the inspection documents as specified in ISO 10474 or another standard, e.g. regional standards EN 10204 or JIS G 0415. The type of document shall be agreed upon at the time of enquiry and order. If the order does not contain any specification of this type, a test report 2.2 shall be issued.

8.1.2 If, in accordance with the agreements made at the time of enquiry and order, a test report 2.2 is to be provided, this shall cover the following information:

- a) confirmation that the material complies with the requirements of the order;
- b) results of the cast analysis for all elements specified in Table 3 for the steel grade concerned.

8.1.3 If, in accordance with the agreements in the order, an inspection certificate 3.1 or 3.2, is to be provided, the specific inspections and tests described in 8.3 and Clause 9 shall be carried out and the results shall be confirmed in the inspection certificate.

In addition, the inspection certificate shall cover:

- a) confirmation that the material complies with the requirements of the order;
- b) results of the cast analysis for all elements specified in Table 3 for the steel grade concerned;
- c) results of all inspections and tests ordered by supplementary requirements (see Annex B);
- d) the symbol, letters or numbers relating the inspection certificate, test pieces and products to each other.

8.2 Frequency of testing

The amount of testing, the sampling conditions and the test methods to be applied for the verification of the requirements shall be in accordance with the prescriptions of Table 10.

8.3 Specific inspection and testing

8.3.1 Verification of the hardenability, hardness and mechanical properties

For steels being ordered without hardenability requirements, i.e. without the symbol, +H, +HH or +HL in the designation, the hardness requirements or mechanical properties given for the relevant heat-treatment condition in Table 1, column 8, subclause 2, shall, with the following exception, be verified. The requirements given in Table 1, footnote a (mechanical properties of reference test pieces), shall only be verified if supplementary requirement specified in B.1 is ordered.

For steels being ordered with the symbol +H, +HH or +HL in the designation (see Tables 5 and 6), unless otherwise agreed, only the hardenability requirements according to Table 5 or 6 are to be verified.

8.3.2 Visual and dimensional inspection

A sufficient number of products shall be inspected to ensure the compliance with the specification.

9 Test methods

9.1 Chemical analysis

The choice of a suitable physical or chemical analytical method for the analysis shall be at the discretion of the manufacturer. In cases of dispute, the method for product analysis used shall be agreed taking into account the relevant existing International Standards.

NOTE The list of available International Standards on chemical analysis is given in ISO/TR 9769.

9.2 Mechanical tests

9.2.1 Tensile test

The tensile test shall be carried out in accordance with ISO 6892-1.

For the specified yield strength in the tables on mechanical properties in this part of ISO 683, the upper yield strength, R_{eH} , shall be determined.

If a yield phenomenon is not present, the 0,2 % proof strength, $R_{p0,2}$, shall be determined.

9.2.2 Impact test

The impact test shall be carried out in accordance with ISO 148-1.

At the time of enquiry and order, additional requirements concerning the impact energy and the verification at temperatures other than room temperature (0 °C, -20 °C and -40 °C) can be agreed.

NOTE Impact values at lower temperatures cannot be achieved for all steel grades.

The average values of a set of three test pieces shall be equal to or greater than the specified value. One individual value may be below the specified value, provided it is not less than 70 % of that value.

If these conditions are not satisfied, the sample product is rejected and retests may be carried out on the remainder of the test unit.

9.3 Hardness and hardenability tests

9.3.1 Hardness in treatment conditions +A and +S

For products in treatment conditions +A (soft annealed) and +S (treated to improve shearability), the hardness shall be measured in accordance with ISO 6506-1.

9.3.2 Verification of hardenability

As far as available, the manufacturer has the option to verify the hardenability by calculation. The calculation method is left to the discretion of the manufacturer. If agreed at the time of enquiry and order, the manufacturer shall give sufficient information about the calculation for the customer to confirm the result.

If a calculation formula is not available or in the case of dispute, an end quench hardenability test shall be carried out in accordance with ISO 642. The temperature for quenching shall comply with the relevant tables in this part of ISO 683. The hardness values shall be determined in accordance with ISO 6508-1, scale C.

9.3.3 Surface hardness

The surface hardness of steels after flame and induction hardening (see Table 9) shall be determined in accordance with ISO 6508-1, scale C.

9.4 Retests

Retests for steels for quenching and tempering and criteria should be as specified in ISO 404.

10 Marking

The manufacturer shall mark the products or the bundles or boxes containing the products in a suitable way, so that the identification of the cast, the steel type and the origin of the delivery is possible (see B.6).

Table 1 — Combinations of usual heat-treatment conditions at delivery, product forms and requirements according to Tables 3 to 9

| No. | 1 | 2 | 3 | 4 | 5 | 6 | 7 | 8 | | 9 | | |
|-----|--------------------------------------|------------------------------------------------------------------------------------------------------------------------------------------------------------------------------------------------------------------------------------------------------------------------------------------------------|---------------------------|------|----------|--------------|--------------------------|-------------------------------------------------------------------------------|------------------------------------|--------------------------------|------------------------------------------------------|------------------------------------------------|
| 1 | Heat-treatment condition at delivery | Sym- bol | x indicates applicable to | | | | | Applicable requirements if the steel is ordered with the designation given in | | | | |
| | | | Semi-finished products | Bars | Wire rod | Flat product | Hammer and drop forgings | Table 3 | | Table 5 or 6 | | |
| 8.1 | 8.2 | 9.1 | | | | | | 9.2 | 9.3 | | | |
| 2 | Un-treated | None or +U | x | x | x | x | x | Chemical composition according to Tables 3 and 4 | — ^a | | As in column 8.1 and 8.2 (see footnote b to Table 3) | Hardenability values according to Table 5 or 6 |
| 3 | Treated to improve shearability | +S | x | x | — | — | — | | Maximum hardness according to | Table 7 column +S ^a | | |
| 4 | Soft annealed | +A | x | x | x | X | x | | | Table 7 column +A ^a | | |
| 5 | Quenched and tempered | +QT | — | x | — | x | x | | Mechanical properties according to | Table 8 | Not applicable | |
| 6 | Others | Other treatment conditions, for example certain annealing conditions to achieve a certain structure, may be agreed at the time of enquiry and order. The condition "annealed to achieve a spheroidization of the carbides", as required for cold heading and cold extrusion, is covered in ISO 4954. | | | | | | | | | | |

^a The mechanical properties specified in Table 8 for the quenched and tempered condition shall be achievable after appropriate heat treatment if so agreed at the time of enquiry and order (for reference test pieces, see B.1).

Table 2 — Surface condition at delivery

| No. | 1 | 2 | 3 | 4 | 5 | 6 | 7 | 8 | 9 |
|--------------------------------------------------------------------------------------------------------------------------------------------------------------------------------------------------------------------------------------------------------------------------------------------------------------------------------------------------------------------------------------------------------------------|---------------------------------------------|---------------------|------------------|---------------------------------------------|------|----------|---------------|------------------------------------------------|----------------|
| 1 | Surface condition at delivery | | Symbol | Semi-finished products (as blooms, billets) | Bars | Wire rod | Flat products | Hammer and drop forgings (see Note 1 to Scope) | Notes |
| x indicates in general applicable to | | | | | | | | | |
| 2 | Unless otherwise agreed | as hot worked | None or +HW | x ^a | x | x | x | x | — |
| 3 | Particular conditions supplied by agreement | HW + pickled | +PI | x | x | x | x | x | — ^c |
| 4 | | HW + blast cleaned | +BC | x | x | x | x | x | |
| 5 | | HW + rough machined | +RM ^b | — | x | x | — | x | |
| 6 | | others | — | — | x | x | x | x | |
| ^a The term "hot worked" also includes the continuously cast condition (+CC) in the case of semi-finished products. ^b Until the term "rough machined" is defined by, for example machining allowances, the details are to be agreed at the time of enquiry and order. ^c In addition, it may be agreed that the products be oiled or, where appropriate, limed or phosphated. | | | | | | | | | |

Table 3 — Steel grades and chemical composition (applicable to cast analysis)^{abc}

| Steel name | Mass fraction % | | | | | | | | | |
|----------------------|-----------------|---------------------------|--------------|--------|----------------|--------------|--------------|--------------|---------|-----------------|
| | C | Si | Mn | P max. | S | Cr | Mo | Ni | Cu max. | Others |
| Steels without boron | | | | | | | | | | |
| 34Cr4 | 0,30 to 0,37 | 0,10 to 0,40 ^d | 0,60 to 0,90 | 0,025 | ≤ 0,035 | 0,90 to 1,20 | — | — | 0,40 | — |
| 34CrS4 | | | | | 0,020 to 0,040 | | | | | |
| 37Cr4 | 0,34 to 0,41 | 0,10 to 0,40 ^d | 0,60 to 0,90 | 0,025 | ≤ 0,035 | 0,90 to 1,20 | — | — | 0,40 | — |
| 37CrS4 | | | | | 0,020 to 0,040 | | | | | |
| 41Cr4 | 0,38 to 0,45 | 0,10 to 0,40 ^d | 0,60 to 0,90 | 0,025 | ≤ 0,035 | 0,90 to 1,20 | — | — | 0,40 | — |
| 41CrS4 | | | | | 0,020 to 0,040 | | | | | |
| 25CrMo4 | 0,22 to 0,29 | 0,10 to 0,40 ^d | 0,60 to 0,90 | 0,025 | ≤ 0,035 | 0,90 to 1,20 | 0,15 to 0,30 | — | 0,40 | — |
| 25CrMoS4 | | | | | 0,020 to 0,040 | | | | | |
| 34CrMo4 | 0,30 to 0,37 | 0,10 to 0,40 ^d | 0,60 to 0,90 | 0,025 | ≤ 0,035 | 0,90 to 1,20 | 0,15 to 0,30 | — | 0,40 | — |
| 34CrMoS4 | | | | | 0,020 to 0,040 | | | | | |
| 42CrMo4 | 0,38 to 0,45 | 0,10 to 0,40 ^d | 0,60 to 0,90 | 0,025 | ≤ 0,035 | 0,90 to 1,20 | 0,15 to 0,30 | — | 0,40 | — |
| 42CrMoS4 | | | | | 0,020 to 0,040 | | | | | |
| 50CrMo4 | 0,46 to 0,54 | 0,10 to 0,40 ^d | 0,50 to 0,80 | 0,025 | ≤ 0,035 | 0,90 to 1,20 | 0,15 to 0,30 | — | 0,40 | — |
| 41CrNiMo2 | 0,37 to 0,44 | 0,10 to 0,40 ^d | 0,70 to 1,00 | 0,025 | ≤ 0,035 | 0,40 to 0,60 | 0,15 to 0,30 | 0,40 to 0,70 | 0,40 | — |
| 41CrNiMoS2 | | | | | 0,020 to 0,040 | | | | | |
| 51CrV4 | 0,47 to 0,55 | 0,10 to 0,40 ^d | 0,60 to 1,00 | 0,025 | ≤ 0,025 | 0,80 to 1,10 | — | — | 0,40 | V: 0,10 to 0,25 |
| 36CrNiMo4 | 0,32 to 0,40 | 0,10 to 0,40 ^d | 0,50 to 0,80 | 0,025 | ≤ 0,035 | 0,90 to 1,20 | 0,15 to 0,30 | 0,90 to 1,20 | 0,40 | — |
| 34CrNiMo6 | 0,30 to 0,38 | 0,10 to 0,40 ^d | 0,50 to 0,80 | 0,025 | ≤ 0,035 | 1,30 to 1,70 | 0,15 to 0,30 | 1,30 to 1,70 | 0,40 | — |
| 30CrNiMo8 | 0,26 to 0,34 | 0,10 to 0,40 ^d | 0,50 to 0,80 | 0,025 | ≤ 0,035 | 1,80 to 2,20 | 0,30 to 0,50 | 1,80 to 2,20 | 0,40 | — |

Table 3 (continued)

| Steel name | Mass fraction % | | | | | | | | | |
|-------------------------------------------------------------------------------------------------------------------------------------------------------------------------------------------------------------------------------------------------------------------------------------------------------------------------------------------------------------------------------------------------------------------------------------------------------------------------------------------------------------------------------------------------------------------------------------------------------------------------------------------------------------------------------------------------------------------------------------------------------------------------------------------------------------------------------------------------------------------------------------------------------------------------------------------------------------------------------------------------------------------------------------------------------------------------------------------------------------------------------------------------------------|--------------------|------|-----------------|-----------|---------|--------------|----|----|------------|------------------------|
| | C | Si | Mn | P max. | S | Cr | Mo | Ni | Cu max. | Others |
| Steels with boron | | | | | | | | | | |
| 20MnB5 | 0,17 to 0,23 | 0,40 | 1,10 to 1,40 | 0,025 | ≤ 0,035 | – | – | – | 0,40 | B: 0,0008 to 0,0050 |
| 30MnB5 | 0,27 to 0,33 | 0,40 | 1,15 to 1,45 | 0,025 | ≤ 0,035 | – | – | – | 0,40 | B: 0,0008 to 0,0050 |
| 39MnB5 | 0,36 to 0,42 | 0,40 | 1,15 to 1,45 | 0,025 | ≤ 0,035 | – | – | – | 0,40 | B: 0,0008 to 0,0050 |
| 27MnCrB5-2 | 0,24 to 0,30 | 0,40 | 1,10 to 1,40 | 0,025 | ≤ 0,035 | 0,30 to 0,60 | – | – | 0,40 | B: 0,0008 to 0,0050 |
| 33MnCrB5-2 | 0,30 to 0,36 | 0,40 | 1,20 to 1,50 | 0,025 | ≤ 0,035 | 0,30 to 0,60 | – | – | 0,40 | B: 0,0008 to 0,0050 |
| 39MnCrB6-2 | 0,36 to 0,42 | 0,40 | 1,40 to 1,70 | 0,025 | ≤ 0,035 | 0,30 to 0,60 | – | – | 0,40 | B: 0,0008 to 0,0050 |
| <p>a Elements not quoted shall not be intentionally added to the steel without the agreement of the purchaser, other than for the purpose of finishing the heat. All reasonable precautions should be taken to prevent the addition, from scrap or other material used in manufacture, of such elements, which affect the hardenability, mechanical properties and applicability.</p> <p>b In the case of grades with specified hardenability requirements (see Tables 5 and 6), except for phosphorus and sulfur, insignificant deviations from the limits for cast analysis are permissible; these deviations shall, however, not exceed in the case of carbon $\pm 0,01$ % and in all other cases, the values according to Table 4.</p> <p>c Steels with improved machinability either by higher sulfur levels up to about 0,10 % S (including controlled sulfide morphology) or lead additions may be available on request. In the first case, the upper limit of the Mn-content may be increased by 0,15 %.</p> <p>d Steels may be supplied with a lower silicon content. In this case, alternative means of deoxidation shall be used.</p> | | | | | | | | | | |

Table 4 — Permissible deviations between the product analysis and the limiting values given in Table 3 for the cast analysis

| Element | Permissible maximum content according to cast analysis | Permissible deviation ^a |
|---------|-----------------------------------------------------------|------------------------------------|
| | mass fraction % | mass fraction % |
| C | ≤ 0,30 | ±0,02 |
| | 0,30 < C ≤ 0,55 | ± 0,03 |
| Si | ≤ 0,40 | ±0,03 |
| Mn | ≤ 1,00 | ±0,04 |
| | 1,00 < Mn ≤ 1,70 | ± 0,06 |
| P | ≤ 0,045 | + 0,005 |
| S | ≤ 0,045 | ±0,005 |
| Cr | ≤ 2,00 | ±0,05 |
| | 2,00 < Cr ≤ 2,20 | ± 0,10 |
| Cu | ≤ 0,40 | + 0,05 |
| Mo | ≤ 0,30 | ±0,03 |
| | 0,30 < Mo ≤ 0,50 | ± 0,04 |
| Ni | ≤ 1,00 | ±0,03 |
| | 1,00 < Ni ≤ 2,00 | ± 0,05 |
| | 2,00 < Ni ≤ 2,20 | ± 0,07 |
| V | ≤ 0,25 | ±0,02 |
| B | ≤ 0,005 0 | ±0,000 3 |

a ± means that in one cast the deviation may occur over the upper value or under the lower value of the specified range in Table 3, but not both at the same time.

Table 5 — Hardness limits for steel grades with specified (normal) hardenability (+H grades; see 7.1.4)

| Steel name | Symbol | Limits of range | Hardness HRC at a distance, in millimetres, from quenched end of test piece of | | | | | | | | | | | | | | |
|-------------------------|--------|-----------------|--------------------------------------------------------------------------------|----|----|----|----|----|----|----|----|----|----|----|----|----|----|
| | | | 1,5 | 3 | 5 | 7 | 9 | 11 | 13 | 15 | 20 | 25 | 30 | 35 | 40 | 45 | 50 |
| Steels without boron | | | | | | | | | | | | | | | | | |
| 34Cr4 34CrS4 | +H | max. | 57 | 57 | 56 | 54 | 52 | 49 | 46 | 44 | 39 | 37 | 35 | 34 | 33 | 32 | 31 |
| | | min. | 49 | 48 | 45 | 41 | 35 | 32 | 29 | 27 | 23 | 21 | 20 | - | - | - | - |
| 37Cr4 37CrS4 | +H | max. | 59 | 59 | 58 | 57 | 55 | 52 | 50 | 48 | 42 | 39 | 37 | 36 | 35 | 34 | 33 |
| | | min. | 51 | 50 | 48 | 44 | 39 | 36 | 33 | 31 | 26 | 24 | 22 | 20 | - | - | - |
| 41Cr4 41CrS4 | +H | max. | 61 | 61 | 60 | 59 | 58 | 56 | 54 | 52 | 46 | 42 | 40 | 38 | 37 | 36 | 35 |
| | | min. | 53 | 52 | 50 | 47 | 41 | 37 | 34 | 32 | 29 | 26 | 23 | 21 | - | - | - |
| 25CrMo4 25CrMoS4 | +H | max. | 52 | 52 | 51 | 50 | 48 | 46 | 43 | 41 | 37 | 35 | 33 | 32 | 31 | 31 | 31 |
| | | min. | 44 | 43 | 40 | 37 | 34 | 32 | 29 | 27 | 23 | 21 | 20 | - | - | - | - |
| 34CrMo4 34CrMoS4 | +H | max. | 57 | 57 | 57 | 56 | 55 | 54 | 53 | 52 | 48 | 45 | 43 | 41 | 40 | 40 | 39 |
| | | min. | 49 | 49 | 48 | 45 | 42 | 39 | 36 | 34 | 30 | 28 | 27 | 26 | 25 | 24 | 24 |
| 42CrMo4 42CrMoS4 | +H | max. | 61 | 61 | 61 | 60 | 60 | 59 | 59 | 58 | 56 | 53 | 51 | 48 | 47 | 46 | 45 |
| | | min. | 53 | 53 | 52 | 51 | 49 | 43 | 40 | 37 | 34 | 32 | 31 | 30 | 30 | 29 | 29 |
| 50CrMo4 | +H | max. | 65 | 65 | 64 | 64 | 63 | 63 | 63 | 62 | 61 | 60 | 58 | 57 | 55 | 54 | 54 |
| | | min. | 58 | 58 | 57 | 55 | 54 | 53 | 51 | 48 | 45 | 41 | 39 | 38 | 37 | 36 | 36 |
| 41CrNiMo2 41CrNiMoS2 | +H | max. | 60 | 60 | 60 | 59 | 58 | 57 | 55 | 54 | 48 | 42 | 40 | 38 | 37 | 37 | 36 |
| | | min. | 53 | 53 | 52 | 50 | 47 | 42 | 38 | 35 | 30 | 28 | 26 | 25 | 24 | 24 | 23 |
| 51CrV4 | +H | max. | 65 | 65 | 64 | 64 | 63 | 62 | 62 | 61 | 60 | 58 | 57 | 55 | 54 | 53 | 53 |
| | | min. | 57 | 56 | 55 | 54 | 53 | 52 | 50 | 48 | 44 | 41 | 37 | 35 | 34 | 33 | 32 |
| 36CrNiMo4 | +H | max. | 59 | 59 | 58 | 58 | 57 | 57 | 57 | 56 | 55 | 54 | 53 | 52 | 51 | 50 | 49 |
| | | min. | 51 | 50 | 49 | 49 | 48 | 47 | 46 | 45 | 43 | 41 | 39 | 38 | 36 | 34 | 33 |
| 34CrNiMo6 | +H | max. | 58 | 58 | 58 | 58 | 57 | 57 | 57 | 57 | 57 | 57 | 57 | 57 | 57 | 57 | 57 |
| | | min. | 50 | 50 | 50 | 50 | 49 | 48 | 48 | 48 | 48 | 47 | 47 | 47 | 46 | 45 | 44 |
| 30CrNiMo8 | +H | max. | 56 | 56 | 56 | 56 | 55 | 55 | 55 | 55 | 55 | 54 | 54 | 54 | 54 | 54 | 54 |
| | | min. | 48 | 48 | 48 | 48 | 47 | 47 | 47 | 46 | 46 | 45 | 45 | 44 | 44 | 43 | 43 |
| Steels with boron | | | | | | | | | | | | | | | | | |
| 20MnB5 | +H | max. | 50 | 49 | 49 | 49 | 47 | 45 | 43 | 41 | 33 | 27 | - | - | - | - | - |
| | | min. | 42 | 41 | 40 | 37 | 30 | 22 | - | - | - | - | - | - | - | - | - |
| 30MnB5 | +H | max. | 56 | 55 | 55 | 54 | 53 | 51 | 50 | 47 | 40 | 37 | 33 | - | - | - | - |
| | | min. | 47 | 46 | 45 | 44 | 42 | 39 | 36 | 31 | 22 | - | - | - | - | - | - |
| 39MnB5 | +H | max. | 60 | 60 | 59 | 58 | 57 | 57 | 55 | 53 | 48 | 41 | 37 | 33 | 31 | - | - |
| | | min. | 52 | 51 | 50 | 49 | 47 | 44 | 41 | 35 | 28 | 24 | 20 | - | - | - | - |
| 27MnCrB5-2 | +H | max. | 55 | 55 | 55 | 54 | 54 | 53 | 52 | 51 | 47 | 44 | 40 | 37 | - | - | - |
| | | min. | 47 | 46 | 45 | 44 | 43 | 41 | 39 | 36 | 30 | 24 | 20 | - | - | - | - |
| 33MnCrB5-2 | +H | max. | 57 | 57 | 57 | 57 | 57 | 56 | 55 | 54 | 53 | 50 | 47 | 45 | - | - | - |
| | | min. | 48 | 47 | 47 | 46 | 45 | 44 | 43 | 41 | 36 | 31 | 25 | 20 | - | - | - |
| 39MnCrB6-2 | +H | max. | 59 | 59 | 59 | 59 | 58 | 58 | 58 | 58 | 57 | 57 | 56 | 55 | 54 | - | - |
| | | min. | 51 | 51 | 51 | 51 | 50 | 50 | 50 | 49 | 47 | 45 | 40 | 35 | 32 | - | - |

Table 6 — Hardness limits for steels with narrowed hardenability scatterbands (+HH and +HL grades)

| Steel name | Symbol | Limits of range | Hardness HRC at a distance, in millimetres, from quenched end of test piece of | | | | | | | | | | | | | | |
|-----------------|--------|-----------------|--------------------------------------------------------------------------------|----|----|----|----|----|----|----|----|----|----|----|----|----|----|
| | | | 1,5 | 3 | 5 | 7 | 9 | 11 | 13 | 15 | 20 | 25 | 30 | 35 | 40 | 45 | 50 |
| 34Cr4 34CrS4 | +HH | max. | 57 | 57 | 56 | 54 | 52 | 49 | 46 | 44 | 39 | 37 | 35 | 34 | 33 | 32 | 31 |
| | | min. | 52 | 51 | 49 | 45 | 41 | 38 | 35 | 33 | 28 | 26 | 25 | 24 | 23 | 22 | 21 |
| | +HL | max. | 54 | 54 | 52 | 50 | 46 | 43 | 40 | 38 | 34 | 32 | 30 | 29 | 28 | 27 | 26 |
| | | min. | 49 | 48 | 45 | 41 | 35 | 32 | 29 | 27 | 23 | 21 | 20 | - | - | - | - |

Table 6 (continued)

| Steel name | Sym- bol | Limits of range | Hardness HRC at a distance, in millimetres, from quenched end of test piece of | | | | | | | | | | | | | | |
|-------------------------|-------------|-----------------------|--------------------------------------------------------------------------------|----|----|----|----|----|----|----|----|----|----|----|----|----|----|
| | | | 1,5 | 3 | 5 | 7 | 9 | 11 | 13 | 15 | 20 | 25 | 30 | 35 | 40 | 45 | 50 |
| 37Cr4 37CrS4 | +HH | max. | 59 | 59 | 58 | 57 | 55 | 52 | 50 | 48 | 42 | 39 | 37 | 36 | 35 | 34 | 33 |
| | | min. | 54 | 53 | 51 | 48 | 44 | 41 | 39 | 37 | 31 | 29 | 27 | 25 | 24 | 23 | 22 |
| | +HL | max. | 56 | 56 | 55 | 53 | 50 | 47 | 44 | 42 | 37 | 34 | 32 | 31 | 30 | 29 | 28 |
| | | min. | 51 | 50 | 48 | 44 | 39 | 36 | 33 | 31 | 26 | 24 | 22 | 20 | – | – | – |
| 41Cr4 41CrS4 | +HH | max. | 61 | 61 | 60 | 59 | 58 | 56 | 54 | 52 | 46 | 42 | 40 | 38 | 37 | 36 | 35 |
| | | min. | 56 | 55 | 53 | 51 | 47 | 43 | 41 | 39 | 35 | 31 | 29 | 27 | 26 | 25 | 24 |
| | +HL | max. | 58 | 58 | 57 | 55 | 52 | 50 | 47 | 45 | 40 | 37 | 34 | 32 | 31 | 30 | 29 |
| | | min. | 53 | 52 | 50 | 47 | 41 | 37 | 34 | 32 | 29 | 26 | 23 | 21 | – | – | – |
| 25CrMo4 25CrMoS4 | +HH | max. | 52 | 52 | 51 | 50 | 48 | 46 | 43 | 41 | 37 | 35 | 33 | 32 | 31 | 31 | 31 |
| | | min. | 47 | 46 | 44 | 41 | 39 | 37 | 34 | 32 | 28 | 26 | 24 | 23 | 22 | 22 | 22 |
| | +HL | max. | 49 | 49 | 47 | 46 | 43 | 41 | 38 | 36 | 32 | 30 | 29 | 28 | 27 | 27 | 27 |
| | | min. | 44 | 43 | 40 | 37 | 34 | 32 | 29 | 27 | 23 | 21 | 20 | – | – | – | – |
| 34CrMo4 34CrMoS4 | +HH | max. | 57 | 57 | 57 | 56 | 55 | 54 | 53 | 52 | 48 | 45 | 43 | 41 | 40 | 40 | 39 |
| | | min. | 52 | 52 | 51 | 49 | 46 | 44 | 42 | 40 | 36 | 34 | 32 | 31 | 30 | 29 | 29 |
| | +HL | max. | 54 | 54 | 54 | 52 | 51 | 49 | 47 | 46 | 42 | 39 | 38 | 36 | 35 | 35 | 34 |
| | | min. | 49 | 49 | 48 | 45 | 42 | 39 | 36 | 34 | 30 | 28 | 27 | 26 | 25 | 24 | 24 |
| 42CrMo4 42CrMoS4 | +HH | max. | 61 | 61 | 61 | 60 | 60 | 59 | 59 | 58 | 56 | 53 | 51 | 48 | 47 | 46 | 45 |
| | | min. | 56 | 56 | 55 | 54 | 52 | 48 | 46 | 44 | 41 | 39 | 38 | 36 | 36 | 35 | 34 |
| | +HL | max. | 58 | 58 | 58 | 57 | 56 | 54 | 53 | 51 | 49 | 46 | 44 | 42 | 41 | 40 | 40 |
| | | min. | 53 | 53 | 52 | 51 | 49 | 43 | 40 | 37 | 34 | 32 | 31 | 30 | 30 | 29 | 29 |
| 50CrMo4 | +HH | max. | 65 | 65 | 64 | 64 | 63 | 63 | 63 | 62 | 61 | 60 | 58 | 57 | 55 | 54 | 54 |
| | | min. | 60 | 60 | 59 | 58 | 57 | 56 | 55 | 53 | 50 | 47 | 45 | 44 | 43 | 42 | 42 |
| | +HL | max. | 63 | 63 | 62 | 61 | 60 | 60 | 59 | 57 | 56 | 54 | 52 | 51 | 49 | 48 | 48 |
| | | min. | 58 | 58 | 57 | 55 | 54 | 53 | 51 | 48 | 45 | 41 | 39 | 38 | 37 | 36 | 36 |
| 41CrNiMo2 41CrNiMoS2 | +HH | max. | 60 | 60 | 60 | 59 | 58 | 57 | 55 | 54 | 48 | 42 | 40 | 38 | 37 | 37 | 36 |
| | | min. | 55 | 55 | 55 | 53 | 51 | 47 | 44 | 41 | 36 | 33 | 31 | 29 | 28 | 28 | 27 |
| | +HL | max. | 58 | 58 | 57 | 56 | 54 | 52 | 49 | 48 | 42 | 37 | 35 | 34 | 33 | 33 | 32 |
| | | min. | 53 | 53 | 52 | 50 | 47 | 42 | 38 | 35 | 30 | 28 | 26 | 25 | 24 | 24 | 23 |
| 51CrV4 | +HH | max. | 65 | 65 | 64 | 64 | 63 | 62 | 62 | 61 | 60 | 58 | 57 | 55 | 54 | 53 | 53 |
| | | min. | 60 | 59 | 58 | 57 | 56 | 55 | 54 | 52 | 49 | 47 | 44 | 42 | 41 | 40 | 39 |
| | +HL | max. | 62 | 62 | 61 | 61 | 60 | 59 | 58 | 57 | 55 | 52 | 50 | 48 | 47 | 46 | 46 |
| | | min. | 57 | 56 | 55 | 54 | 53 | 52 | 50 | 48 | 44 | 41 | 37 | 35 | 34 | 33 | 32 |
| 36CrNiMo4 | +HH | max. | 59 | 59 | 58 | 58 | 57 | 57 | 57 | 56 | 55 | 54 | 53 | 52 | 51 | 50 | 49 |
| | | min. | 54 | 53 | 52 | 52 | 51 | 50 | 50 | 49 | 47 | 45 | 44 | 43 | 41 | 39 | 38 |
| | +HL | max. | 56 | 56 | 55 | 55 | 54 | 54 | 53 | 52 | 51 | 50 | 48 | 47 | 46 | 45 | 44 |
| | | min. | 51 | 50 | 49 | 49 | 48 | 47 | 46 | 45 | 43 | 41 | 39 | 38 | 36 | 34 | 33 |
| 34CrNiMo6 | +HH | max. | 58 | 58 | 58 | 58 | 57 | 57 | 57 | 57 | 57 | 57 | 57 | 57 | 57 | 57 | 57 |
| | | min. | 53 | 53 | 53 | 53 | 52 | 51 | 51 | 51 | 51 | 50 | 50 | 50 | 50 | 49 | 48 |
| | +HL | max. | 55 | 55 | 55 | 55 | 54 | 54 | 54 | 54 | 54 | 54 | 54 | 54 | 53 | 53 | 53 |
| | | min. | 50 | 50 | 50 | 50 | 49 | 48 | 48 | 48 | 48 | 47 | 47 | 47 | 46 | 45 | 44 |
| 30CrNiMo8 | +HH | max. | 56 | 56 | 56 | 56 | 55 | 55 | 55 | 55 | 55 | 54 | 54 | 54 | 54 | 54 | 54 |
| | | min. | 51 | 51 | 51 | 51 | 50 | 50 | 50 | 49 | 49 | 48 | 48 | 47 | 47 | 47 | 47 |
| | +HL | max. | 53 | 53 | 53 | 53 | 52 | 52 | 52 | 52 | 52 | 51 | 51 | 51 | 51 | 50 | 50 |
| | | min. | 48 | 48 | 48 | 48 | 47 | 47 | 47 | 46 | 46 | 45 | 45 | 44 | 44 | 43 | 43 |

Table 7 — Maximum hardness for products delivered in the conditions “treated to improve shearability” (+S) or “soft annealed” (+A)

| Steel name ^a | HBW max. in condition ^b | |
|-------------------------|------------------------------------|-----|
| | +S | +A |
| 34Cr4, 34CrS4 | 255 | 223 |
| 37Cr4, 37CrS4 | 255 | 235 |
| 41Cr4, 41CrS4 | 255 ^c | 241 |
| 25CrMo4, 25CrMoS4 | 255 | 212 |
| 34CrMo4, 34CrMoS4 | 255 | 223 |
| 42CrMo4, 42CrMoS4 | 255 ^c | 241 |
| 50CrMo4 | .d | 248 |
| 41CrNiMo2, 41CrNiMoS2 | 255 | 217 |
| 51CrV4 | .d | 248 |
| 36CrNiMo4 | .d | 248 |
| 34CrNiMo6 | .d | 248 |
| 30CrNiMo8 | .d | 248 |
| 20MnB5 | .e | .f |
| 30MnB5 | .e | .f |
| 39MnB5 | .e | .f |
| 27MnCrB5-2 | .e | .f |
| 33MnCrB5-2 | 255 | .f |
| 39MnCrB6-2 | 255 | .f |

^a The values apply also to the various hardenability (+H, +HH and +HL) grades covered in Tables 5 and 6; see, however, footnote d.

^b The values are not applicable to continuously cast and not further deformed slabs.

^c Depending on chemical composition and on dimensions, particularly in the case of the +HH grades, soft annealing may be necessary.

^d Where the shearability is of importance, this steel should be ordered in the condition “soft annealed”.

^e Shearable in the untreated condition.

^f Condition +A is not applicable to boron steels.

Table 8 (continued)

| Steel name | Mechanical properties for ruling sections (see Annex A) with a diameter, <i>d</i> , or for flat products with thickness, <i>t</i> , of | | | | | | | | | | | | | | | | | | | | | | | | | | | | | |
|------------|----------------------------------------------------------------------------------------------------------------------------------------|----------------|----------------|-----------------------------|------------------------------|-----------------------------------|-----------------------------------------------------|----------------|-----------------------------|------------------------------|-----------------------------------|-----------------------------|-------------------------------------------------------|-----------------------------|------------------------------|-----------------------------------|----|----------------|---------------------------------------------------------|------------------------------|-----------------------------------|----|----------------|-----------------------------|----------------------------------------------------------|---|--|--|--|--|
| | <i>d</i> ≤ 16 mm <i>t</i> ≤ 8 mm | | | | | | 16 mm < <i>d</i> ≤ 40 mm 8 mm < <i>t</i> ≤ 20 mm | | | | | | 40 mm < <i>d</i> ≤ 100 mm 20 mm < <i>t</i> ≤ 60 mm | | | | | | 100 mm < <i>d</i> ≤ 160 mm 60 mm < <i>t</i> ≤ 100 mm | | | | | | 160 mm < <i>d</i> ≤ 250 mm 100 mm < <i>t</i> ≤ 160 mm | | | | | |
| | Rp0.2 min. MPa ^c | Rm | A min. % | Z ^b min. % | KV ₂ min. J | Rp0.2 min. MPa ^c | Rm | A min. % | Z ^b min. % | KV ₂ min. J | Rp0.2 min. MPa ^c | Rm | A min. % | Z ^b min. % | KV ₂ min. J | Rp0.2 min. MPa ^c | Rm | A min. % | Z ^b min. % | KV ₂ min. J | Rp0.2 min. MPa ^c | Rm | A min. % | Z ^b min. % | KV ₂ min. J | | | | | |
| 20MnB5 | 700 | 900 to 1 050 | 14 | 55 | - ^d | 600 | 750 to 900 | 15 | 55 | 60 ^d | - | - | - | - | - | - | - | - | - | - | - | - | - | - | - | - | | | | |
| 30MnB5 | 800 | 950 to 1 150 | 13 | 50 | - ^d | 650 | 800 to 950 | 13 | 50 | 60 ^d | - | - | - | - | - | - | - | - | - | - | - | - | - | - | - | - | | | | |
| 39MnB5 | 900 | 1 050 to 1 250 | 12 | 50 | - ^d | 700 | 850 to 1 050 | 12 | 50 | 60 ^d | - | - | - | - | - | - | - | - | - | - | - | - | - | - | - | - | | | | |
| 27MnCrB5-2 | 800 | 1 000 to 1 250 | 14 | 55 | - ^d | 750 | 900 to 1 150 | 14 | 55 | 60 ^d | 700 ^e | 800 to 1 000 ^e | 15 ^e | 55 ^e | 65 ^{d,e} | - | - | - | - | - | - | - | - | - | - | - | | | | |
| 33MnCrB5-2 | 850 | 1 050 to 1 300 | 13 | 50 | - ^d | 800 | 950 to 1 200 | 13 | 50 | 50 ^d | 750 ^e | 900 to 1 100 ^e | 13 ^e | 50 ^e | 50 ^{d,e} | - | - | - | - | - | - | - | - | - | - | - | | | | |
| 39MnCrB6-2 | 900 | 1 100 to 1 350 | 12 | 50 | - ^d | 850 | 1 050 to 1 250 | 12 | 50 | 40 ^d | 800 ^e | 1 000 to 1 200 ^e | 12 ^e | 50 ^e | 40 ^{d,e} | - | - | - | - | - | - | - | - | - | - | - | | | | |

a Rp0.2: 0,2 % - proof stress;

Rm: tensile strength; A is the percentage elongation after fracture ($L_0 = 5,65 \sqrt{s_0}$; see Table 12, column 7a, line T4); Z is the reduction in cross-section on fracture;

KV₂: impact strength of longitudinal Charpy V-notch test pieces with striker radius 2 mm, average of 3 individual values, no individual value shall be lower than 70 % of the minimum average value.

b These values are optional and can be agreed at the time of enquiry and order.

c 1 MPa = 1 N/mm².

d If testing of Charpy U-notch impact test pieces is required, the minimum impact strength value shall be agreed.

e Up to *d* ≤ 63 mm diameter and *t* ≤ 35 mm.

Table 9 — Surface hardness for steel grades after flame or induction hardening

| Steel name | Surface hardness |
|-----------------|------------------|
| | HRC min. |
| 46Cr2 | 54 |
| 37Cr4/37CrS4 | 51 |
| 41Cr4/41CrS4 | 53 |
| 42CrMo4/42CrMo4 | 53 |
| 50CrMo4 | 58 |

^a The above values apply to the condition existing after quenching and tempering and surface hardening according to the conditions given in Table 11, followed by stress relieving at 150 °C to 180 °C for about 1 h, and they relate to cross-sections of up to 100 mm in diameter for steels 46Cr2, 37Cr4/37CrS4 and 41Cr4/41CrS4, and up to 250 mm in diameter for steels 42CrMo4/42CrMoS4 and 50CrMo4. It should be noted that surface decarburization may lead to lower hardness values in the surface-hardened zones.

Table 10 — Test conditions for the verification of the requirements given in column 2

| 1 No. | 2 Requirements | 3 Test unit ^a | 4 Amount of testing | | 5 Number of tests per sample product | 6 Sampling (See the supplement to this table, line T1 and line ...) | 7 Test method | Supplement to Table 10, columns 6 and 7 | |
|----------|-----------------------------------------|-----------------------------|--------------------------------------------------------------------------------|------------------------------------|-----------------------------------------|---------------------------------------------------------------------------|------------------|-----------------------------------------|----------------------------------------------------------------------------------------------------------------------------------------------------------------------------------------------------------------------------------------------------------------------------------------------------------------------------------------------------------------------------------------------------------------------------------------------------------------------------------------------------------------------------------------------------------|
| | | | Number of sample products per test unit | Number of tests per sample product | | | | Line | 7a Test method |
| 1 | Chemical composition See Table 4 | C | (The cast analysis is given by the manufacturer; for product analysis see B.4) | | | | | T1 | General conditions The general conditions for selection and preparation of test samples and test pieces for steel shall be in accordance with ISO 377 and ISO 14284. |
| 2 | Hardenability | C | 1 | 1 | T2 | | | T2 | End quench hardenability test In case of dispute, if possible, the sampling method given in ISO 642 under a or b1 shall be applied. In all other cases, the sampling method including the method which starts from separately cast and subsequently hot-worked test ingots or from cast and not hot-worked samples is, unless otherwise agreed at the time of enquiry and order, left to the discretion of the manufacturer. |
| 3 | Hardness in the condition +S or +A | C +D +T | 1 | 1 | T3 | | | T3 | Hardness tests In case of dispute, the hardness shall be measured, if possible, at the surface of the product — at a distance equal to the thickness from one end and in cases of products with square or rectangular cross-section — at a distance of $0,25 \times W$, where W is the width of the product from one longitudinal edge. If for example for hammer and drop forgings the above prescriptions prove unrealistic, a more appropriate position of the hardness indentations shall be agreed at the time of enquiry and order. |

Table 10 (continued)

| | | Supplement to Table 10, columns 6 and 7 | | | | | | | |
|-----|---------------------------------------------------------|---------------------------------------------------------------------------------------------------------------------------------------------------------------------------------------------------------------------------------------------------------------------------------------------------------------------------------------------------------------------------------------------------------------------------------------|-----------------------------------------|----------------------------------------------------|-------------------------------------------------------------------|-------------|------|---------------------------------------------------------------------------------------------------------------------------------------------------------------------------------------------------------------------------------------------------------------------------------------------------------------------------------------------------------------------------------------------------------------------------------------------------------------------------------------------------------------------------------------------------------------------------------------------------------------------------------------------------------------------------------------------------------------------------------------------------------------------------------------------------------------------------------------------------------------------------------------------------------------------------------------------------------------------------------------------------------------------------------------------------------------------------------------------------------------------------------------------------------------------------------------------------------------------------------------------------|-------------|
| 1 | 2 | 3 | 4 | | 6 | 7 | 6a | | |
| | | | Amount of testing | | | | Line | Sampling | Test method |
| No. | Requirements | Test unit ^a | Number of sample products per test unit | Number of tests per sample product | Sampling (See the supplement to this table, line T1 and line ...) | Test method | Line | Test method | |
| 4 | Mechanical properties of quenched and tempered products | C + D + T | 1 | 1 tensile test and 3 CVN-impact tests ^b | T4 | T4 | T4 | <p>Tensile and impact tests</p> <p>The test pieces for tensile test and, where applicable, the test pieces for the Charpy V-notch impact tests shall be taken</p> <ul style="list-style-type: none"> — for bars and wire rod in accordance with Figure 2; — for plates in accordance with Figure 3 and 4. <p>For hammer and drop forgings, the test pieces shall be taken with their longitudinal axis parallel to the direction of principal grain flow from a position to be agreed at the time of enquiry and order.</p> <p>The tensile test shall, in cases of dispute, be carried out in accordance with ISO 6892-1 on proportional test pieces having a gauge length of $L_0 = 5,65 \sqrt{S_0}$, where S_0 is the area of the cross-section of the test piece. Where this is not possible (i.e. for flat products with thicknesses of about < 3 mm), a test piece with constant gauge length in accordance with ISO 6892-1 shall be agreed at the time of enquiry and order.</p> <p>In this case, also the minimum elongation value to be obtained for these test pieces shall be agreed.</p> <p>The impact test, where required, shall be carried out in accordance with ISO 148-1.</p> | |
| | NOTE | Verification of the requirements is only necessary if an inspection certificate or an inspection report is ordered and if the requirement is applicable according to Table 1, column 8 or 9. | | | | | | | |
| | ^a | The tests shall be carried out separately for each cast indicated by "C" (for each dimension as indicated by "D") and for each heat-treatment batch as indicated by "T". Products of different thicknesses may be grouped if the thicknesses lie in the same dimension range for mechanical properties and if the differences do not affect the properties. In cases of doubt, the thinnest and the thickest product shall be tested. | | | | | | | |
| | ^b | Only applicable if values for the impact strength are given in Table 8. | | | | | | | |

Table 11 — Conditions for heat treatment^a

| Steel name ^b | Hardening temperature ^{cd} | Quenching agent ^e | Tempering temperature ^f | End quench test austenitizing temperatures ^g |
|-------------------------|-------------------------------------|------------------------------|------------------------------------|---------------------------------------------------------|
| 34Cr4, 34CrS4 | 830 to 870 | Water or oil | 540 to 680 | 850 ± 5 |
| 37Cr4, 37CrS4 | 825 to 865 | Oil or water | 540 to 680 | 845 ± 5 |
| 41Cr4, 41CrS4 | 820 to 860 | Oil or water | 540 to 680 | 840 ± 5 |
| 25CrMo4, 25CrMoS4 | 840 to 880 | Water or oil | 540 to 680 | 860 ± 5 |
| 34CrMo4, 34CrMoS4 | 830 to 870 | Oil or water | 540 to 680 | 850 ± 5 |
| 42CrMo4, 42CrMoS4 | 820 to 860 | Oil or water | 540 to 680 | 840 ± 5 |
| 50CrMo4 | 820 to 860 | Oil | 540 to 680 | 850 ± 5 |
| 41CrNiMo2, 41CrNiMoS2 | 830 to 860 | Oil or water | 540 to 660 | 845 ± 5 |
| 51CrV4 | 820 to 860 | Oil | 540 to 680 | 850 ± 5 |
| 36CrNiMo4 | 820 to 850 | Oil or water | 540 to 680 | 850 ± 5 |
| 34CrNiMo6 | 830 to 860 | Oil | 540 to 660 | 845 ± 5 |
| 30CrNiMo8 | 830 to 860 | Oil | 540 to 660 | 845 ± 5 |
| 20MnB5 | 880 to 920 | Water | 400 to 600 | 900 ± 5 |
| 30MnB5 | 860 to 900 | Water | 400 to 600 | 880 ± 5 |
| 39MnB5 | 840 to 880 | Water or oil | 400 to 600 | 850 ± 5 |
| 27MnCrB5-2 | 880 to 920 | Water or oil | 400 to 600 | 900 ± 5 |
| 33MnCrB5-2 | 860 to 900 | Oil | 400 to 600 | 880 ± 5 |
| 39MnCrB6-2 | 840 to 880 | Oil | 400 to 600 | 850 ± 5 |

^a The conditions given in this table are for guidance. However, the temperatures specified for the end quench test are mandatory.

^b This table also applies to the various hardenability (+H, +HH and +HL) grades covered in Tables 5 and 6.

^c Temperatures at the lower end of the range are generally used for water, and those at the upper end for oil quenching.

^d Time for austenitizing as a guide: at least 30 min.

^e When choosing the quenching agent, the influence of other parameters, such as shape, dimensions and quenching temperature, on properties and crack susceptibility, should be taken into account. Other quenching agents such as synthetic quenchants may also be used.

^f Time for tempering as a guide: at least 60 min.

^g Time for austenitizing as a guide: 30 min to 35 min.

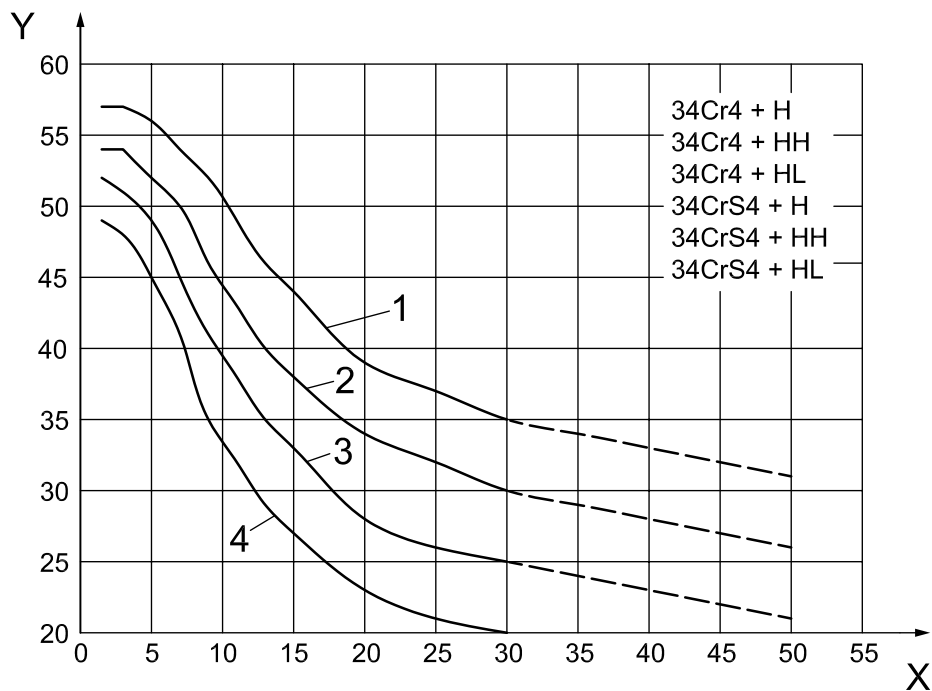

a)

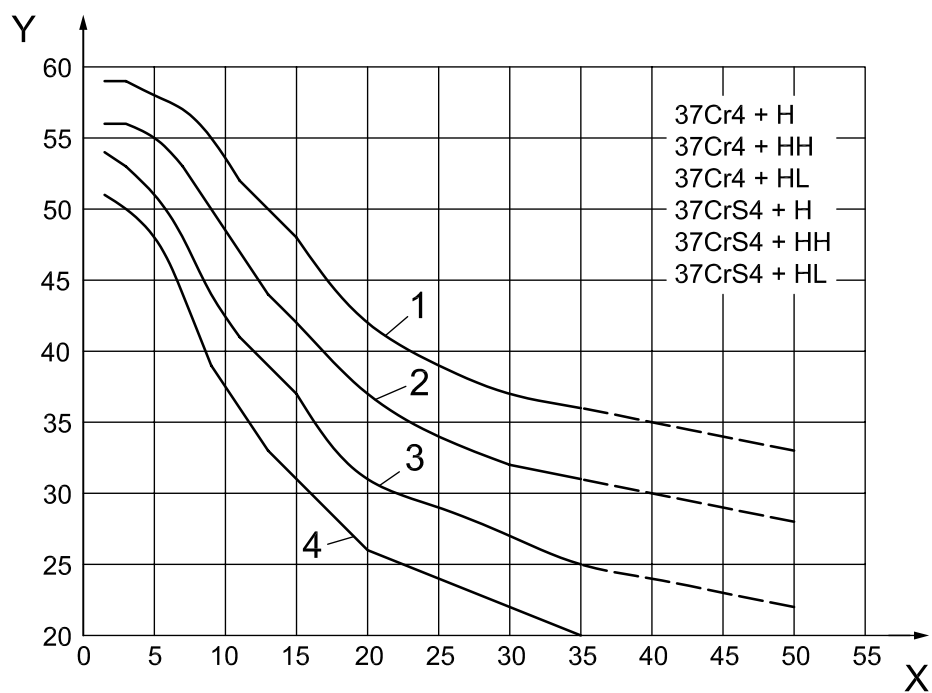

b)

Key

- X distance from quenched end of test piece, mm
- Y hardness, HRC
- 1 upper limit
- 2 upper limit, +HL grades
- 3 lower limit, +HH grades
- 4 lower limit

Figure 1 — Scatter bands for the Rockwell C hardness in the end quench hardenability test (continued)

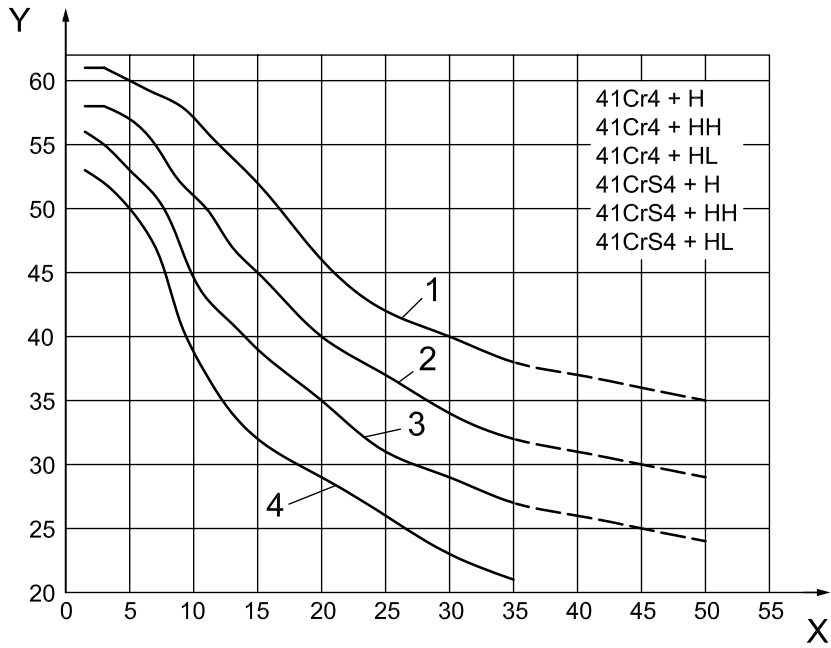

c)

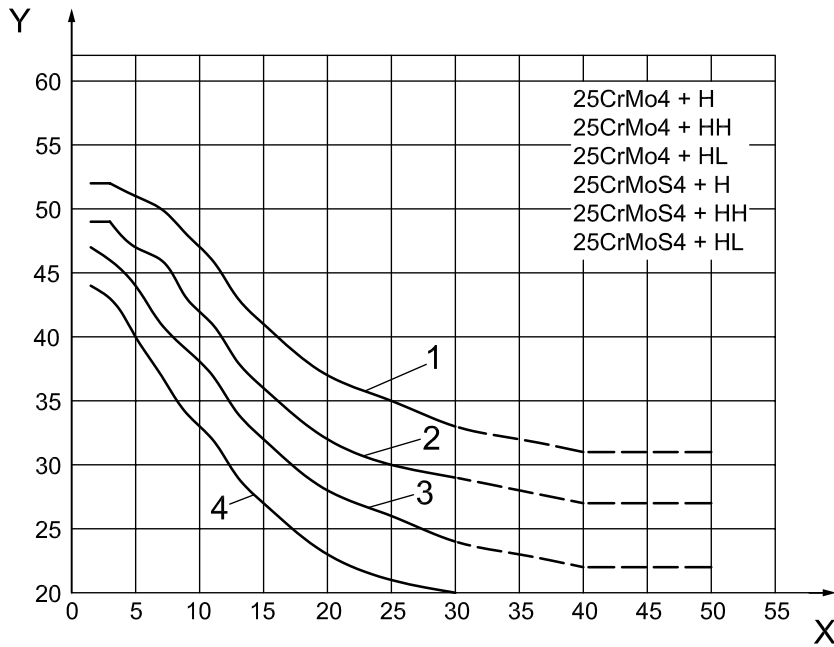

d)

Key

- X distance from quenched end of test piece, mm
- Y hardness, HRC
- 1 upper limit
- 2 upper limit, +HL grades
- 3 lower limit, +HH grades
- 4 lower limit

Figure 1 — Scatter bands for the Rockwell C hardness in the end quench hardenability test (continued)

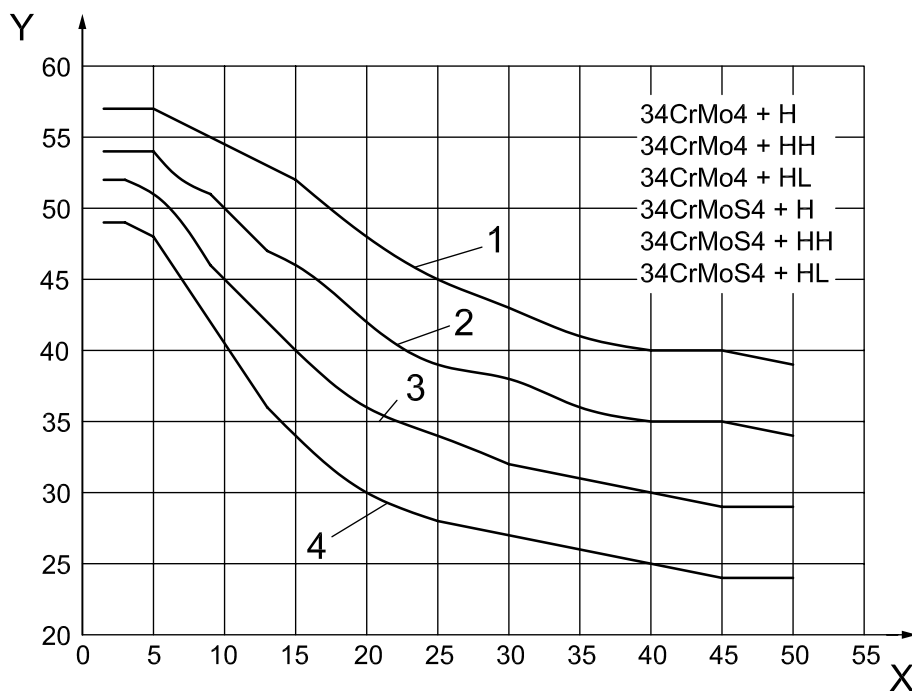

e)

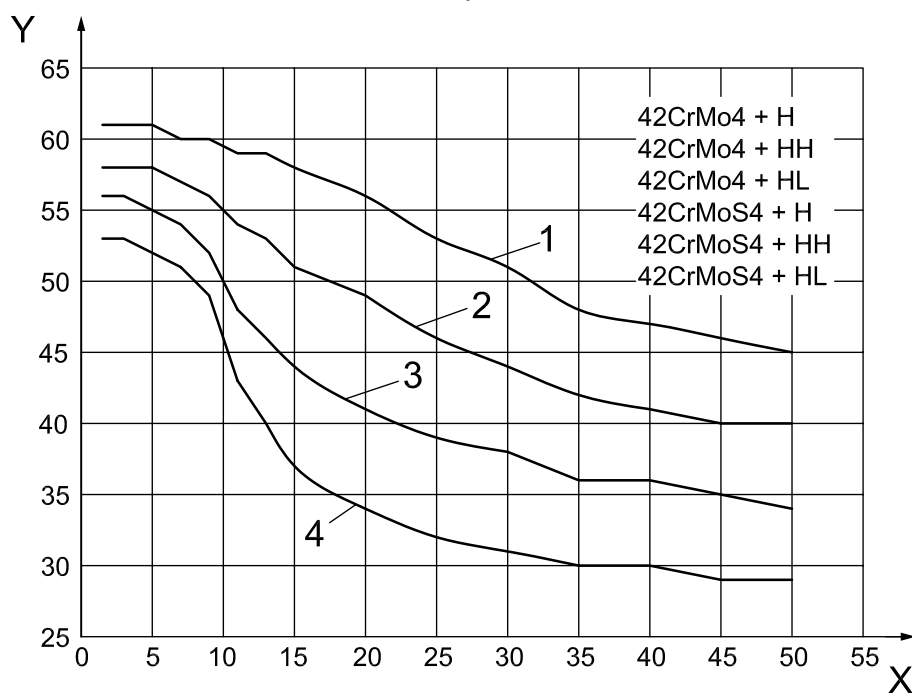

f)

Key

- X distance from quenched end of test piece, mm
- Y hardness, HRC
- 1 upper limit
- 2 upper limit, +HL grades
- 3 lower limit, +HH grades
- 4 lower limit

Figure 1 — Scatter bands for the Rockwell C hardness in the end quench hardenability test (continued)

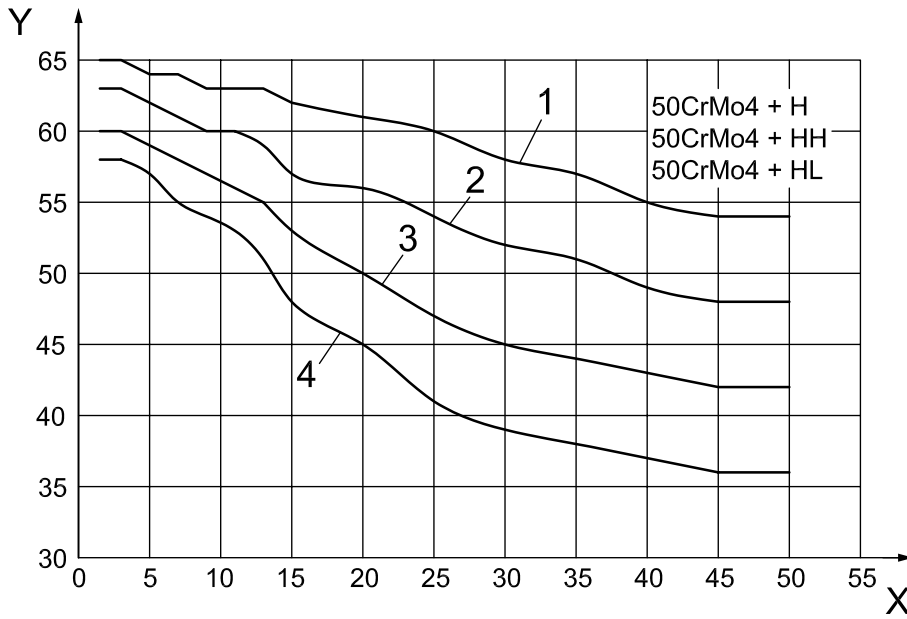

g)

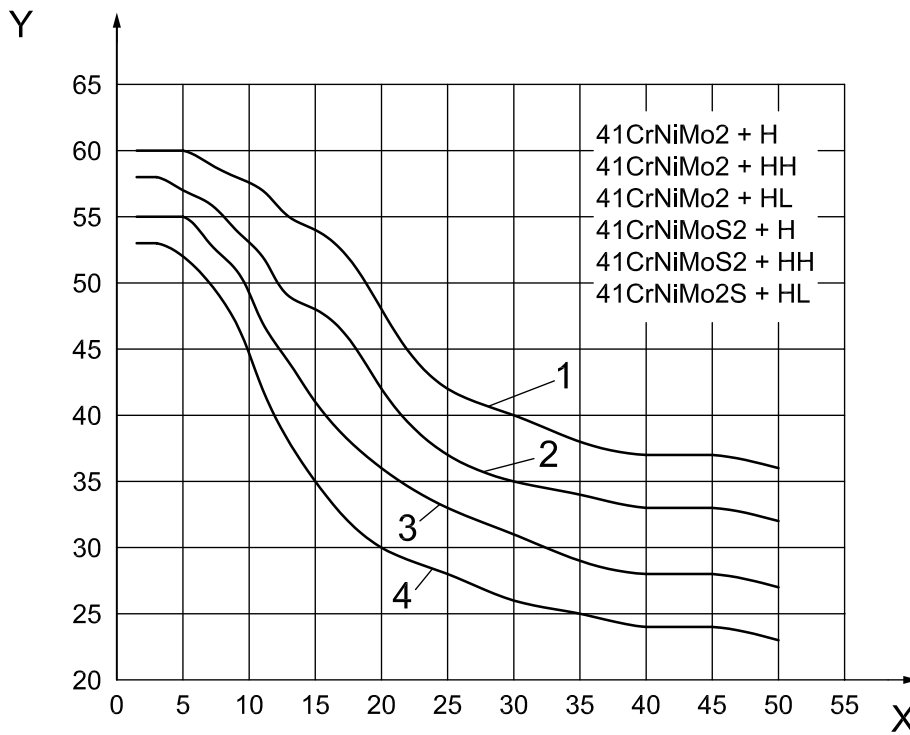

h)

Key

- X distance from quenched end of test piece, mm
- Y hardness, HRC
- 1 upper limit
- 2 upper limit, +HL grades
- 3 lower limit, +HH grades
- 4 lower limit

Figure 1 — Scatter bands for the Rockwell C hardness in the end quench hardenability test (continued)

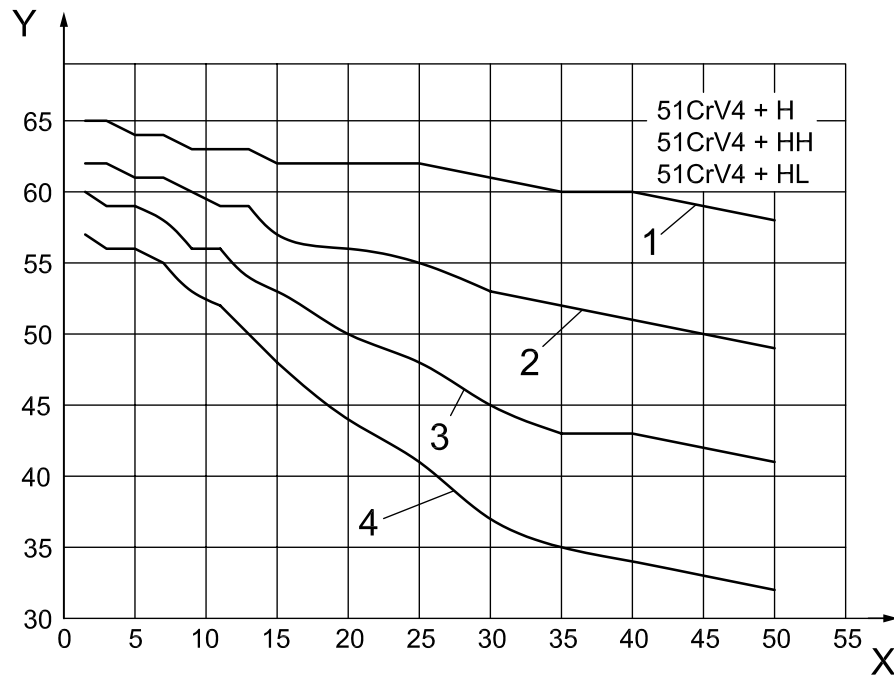

i)

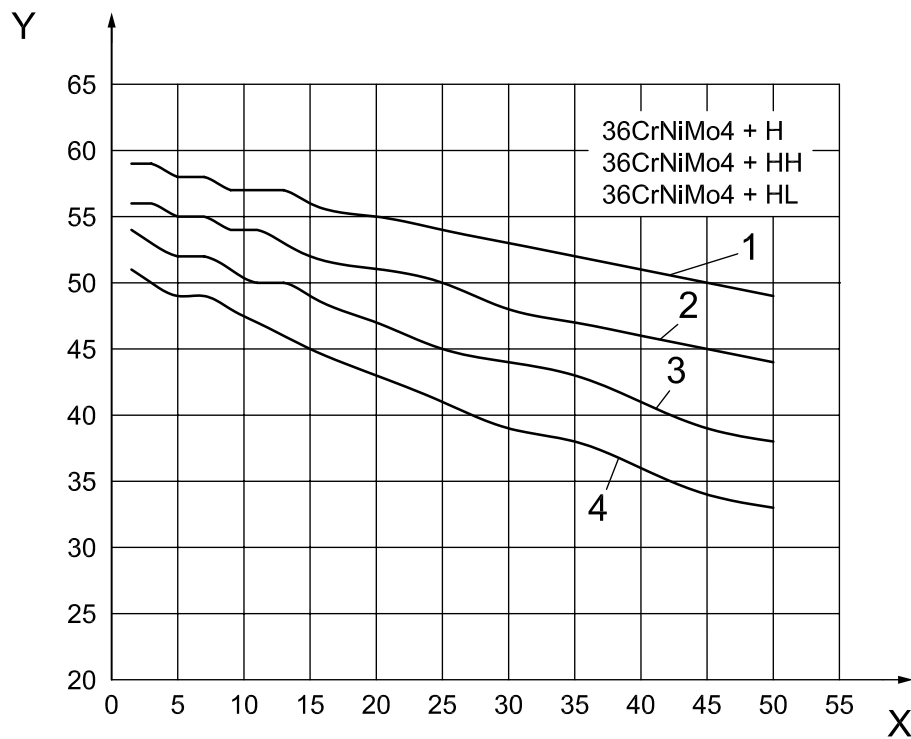

k)

Key

- X distance from quenched end of test piece, mm
- Y hardness, HRC
- 1 upper limit
- 2 upper limit, +HL grades
- 3 lower limit, +HH grades
- 4 lower limit

Figure 1 — Scatter bands for the Rockwell C hardness in the end quench hardenability test (continued)

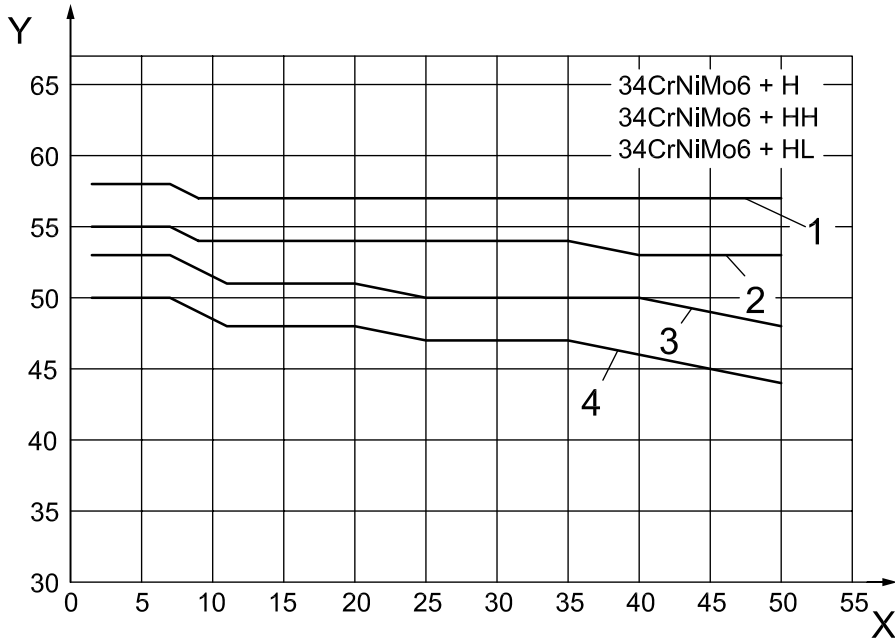

i)

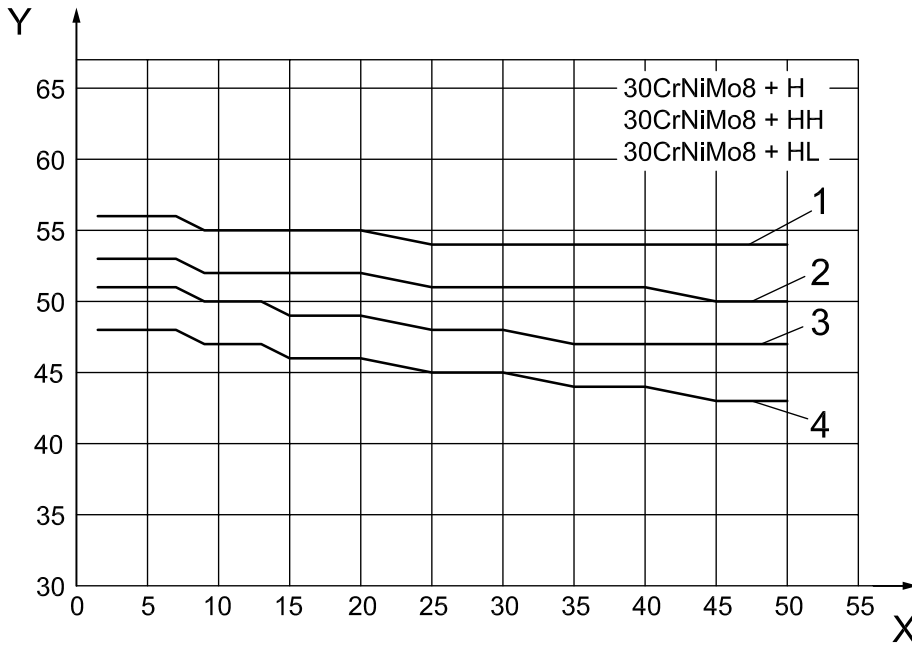

m)

Key

- X distance from quenched end of test piece, mm
- Y hardness, HRC
- 1 upper limit
- 2 upper limit, +HL grades
- 3 lower limit, +HH grades
- 4 lower limit

Figure 1 — Scatter bands for the Rockwell C hardness in the end quench hardenability test (continued)

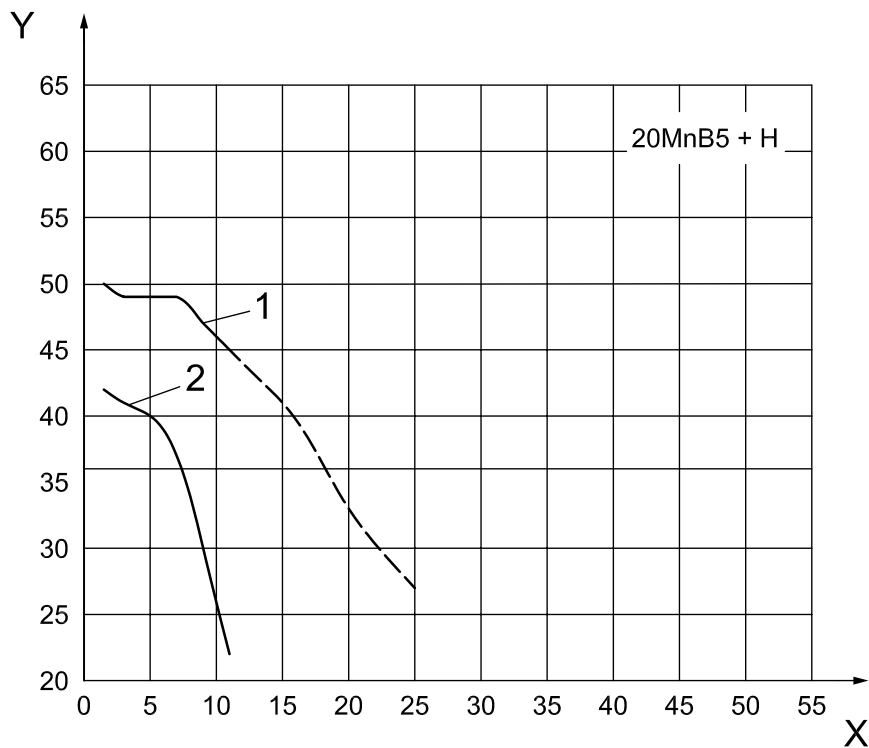

n)

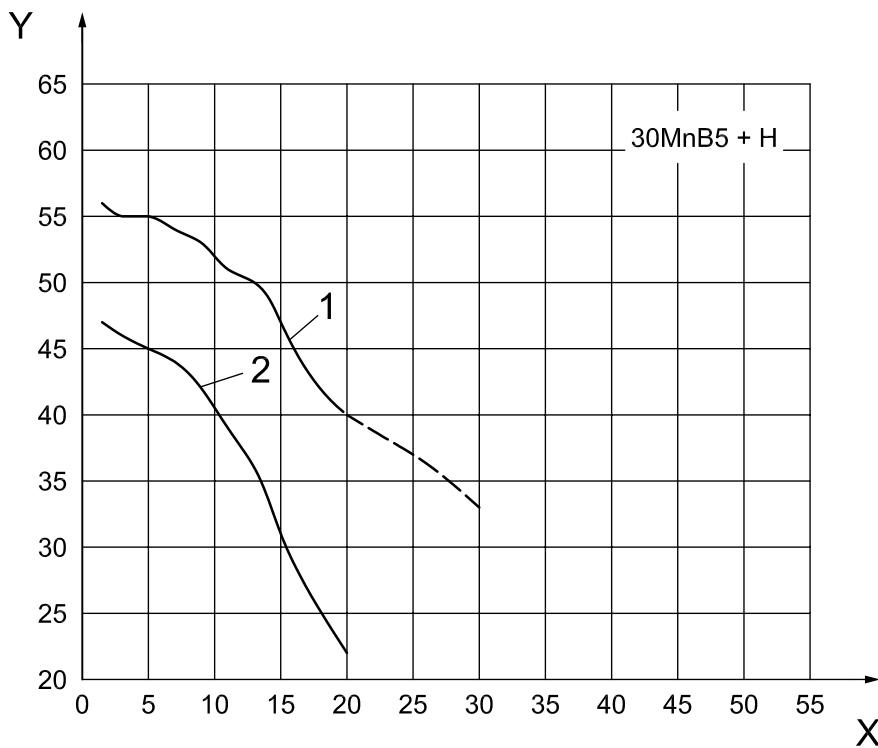

o)

Key

- X distance from quenched end of test piece, mm
- Y hardness, HRC
- 1 upper limit
- 2 lower limit

Figure 1 — Scatter bands for the Rockwell C hardness in the end quench hardenability test (continued)

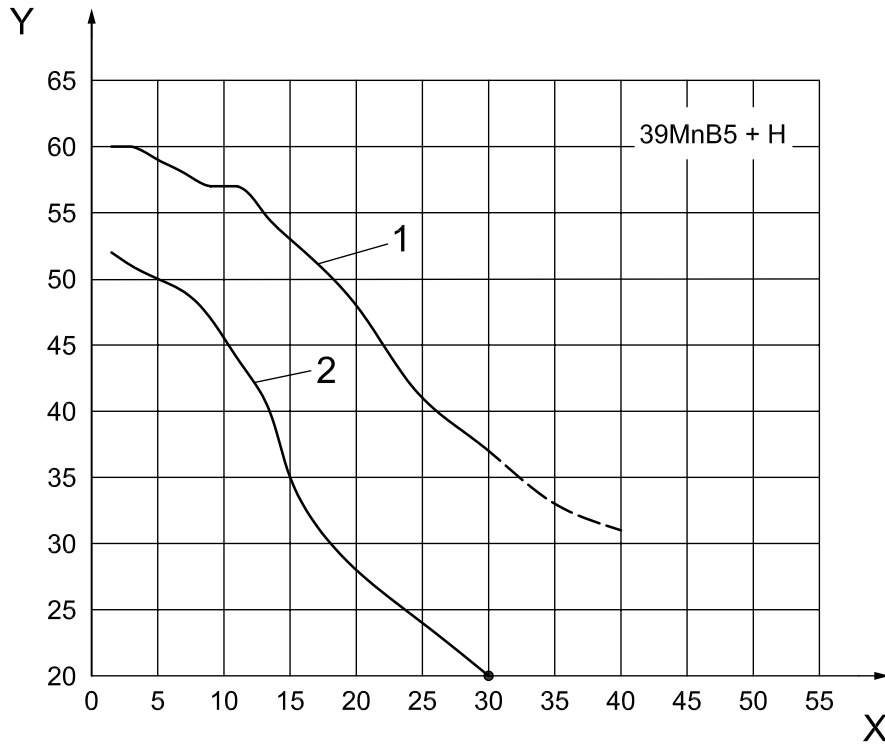

p)

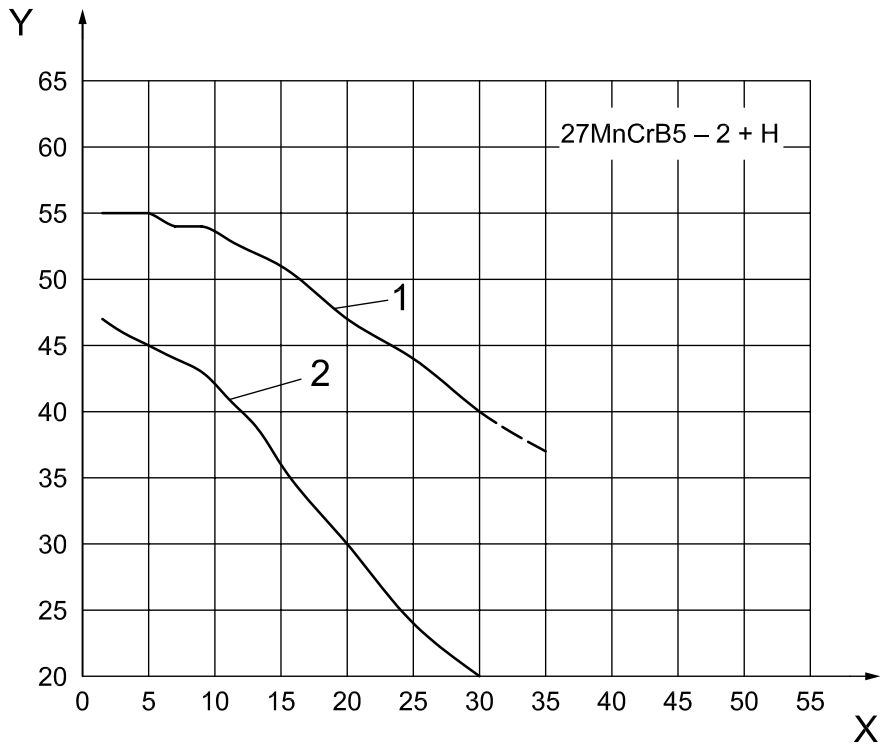

q)

Key

- X distance from quenched end of test piece, mm
- Y hardness, HRC
- 1 upper limit
- 2 lower limit

Figure 1 — Scatter bands for the Rockwell C hardness in the end quench hardenability test (continued)

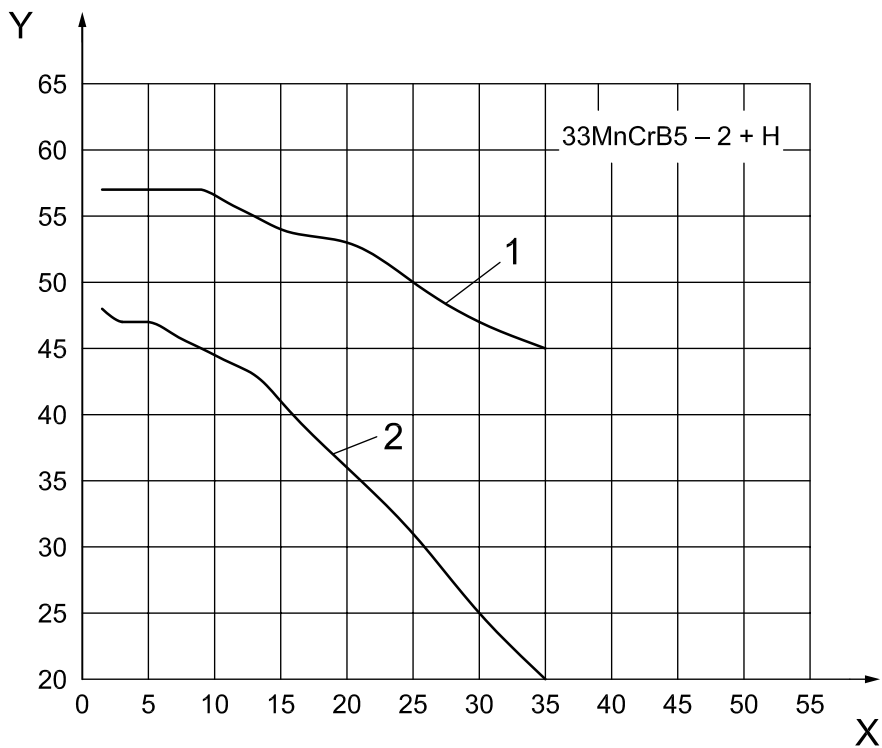

r)

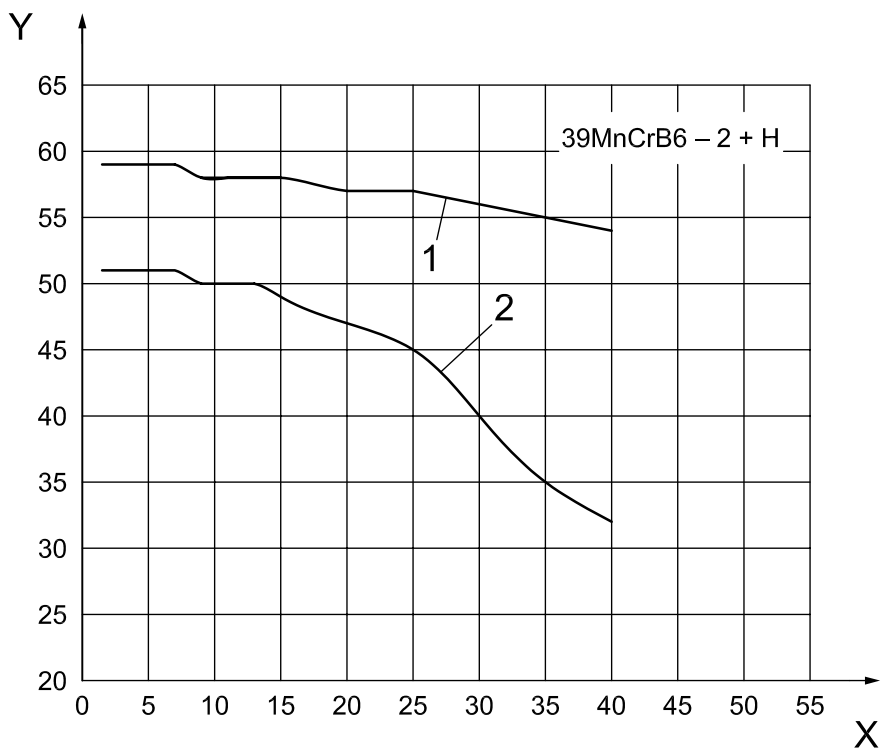

s)

Key

- X distance from quenched end of test piece, mm
- Y hardness, HRC
- 1 upper limit
- 2 lower limit

Figure 1 — Scatter bands for the Rockwell C hardness in the end quench hardenability test

Dimensions in millimetres

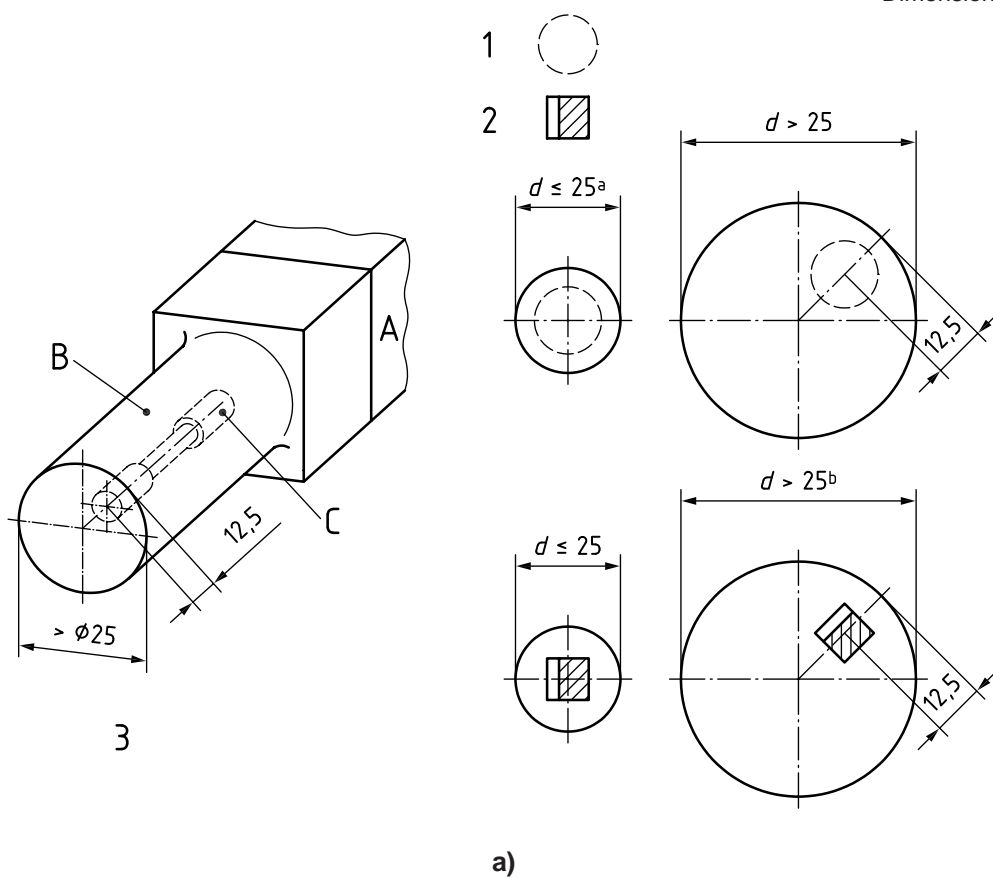
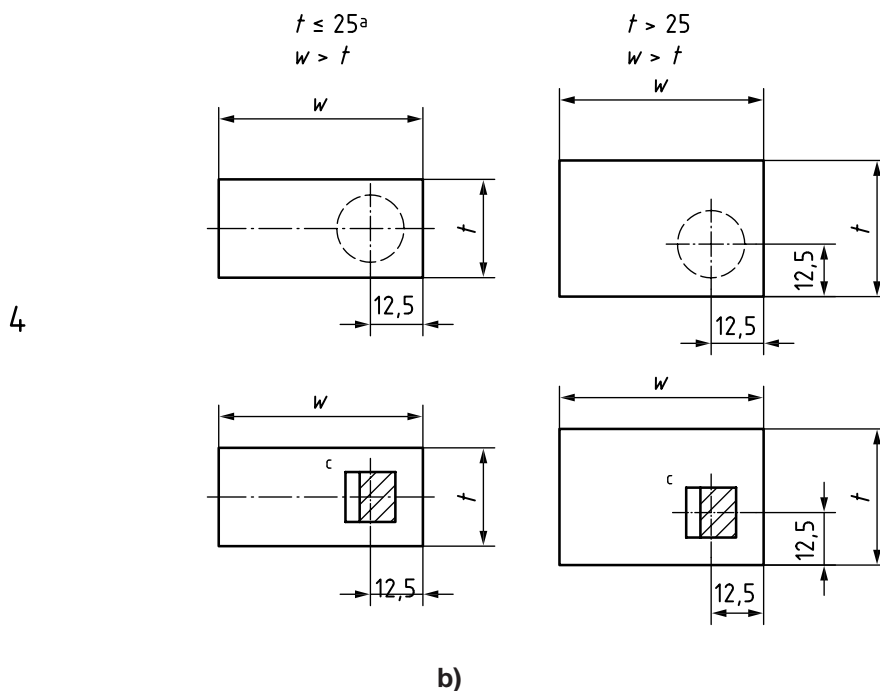

Figure 2 — Location of the test pieces in bars, seamless rolled rings and rods (continued)



Key

- 1 tensile test piece
- 2 notched bar impact test piece
- 3 round and similar shaped sections
- 4 rectangular and square sections

- A sample
- B rough specimen
- C test piece

- a For small products (d or $w \leq 25$ mm), the test piece shall, if possible, consist of an un-machined part of the bar.
- b For round bars, the longitudinal axis of the notch shall be approximately parallel to the direction of a diameter.
- c For rectangular bars, the longitudinal axis of the notch shall be perpendicular to the wider rolling surface.

Figure 2 — Location of the test pieces in bars, seamless rolled rings and rods

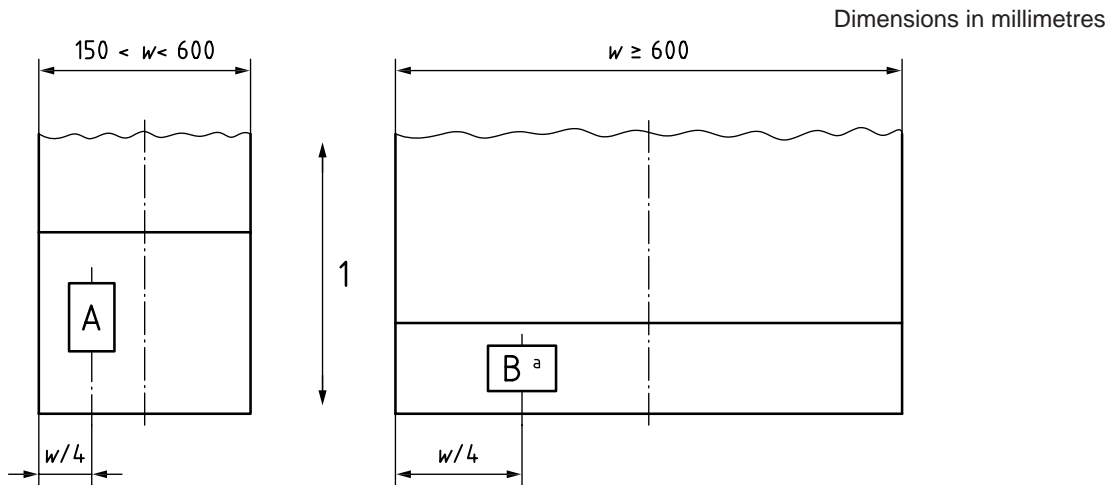

Key

1 principal direction of rolling

NOTE In case of difficulty taking the test piece from $w/4$, take the sample from the position where the centre of it is getting as close as possible to $w/4$.

^a In the case of steel grades in the quenched and tempered condition with requirements for impact energy, the width of the sample shall be sufficient for longitudinal impact test pieces to be taken as specified in Figure 4.

Figure 3 — Location of the samples (A and B) in flat products in relation to the product width

| Type of test | Product thickness | Location of the test piece ^a for a product width of | | Distance of the test piece from the rolled surface |
|---------------------------|-------------------|----------------------------------------------------------------|-----------------|----------------------------------------------------|
| | mm | $w < 600$ mm | $w \geq 600$ mm | mm |
| Tensile test ^b | ≤ 30 | longitudinal | transverse | |
| | > 30 | | | |
| Impact test ^c | $> 12^d$ | longitudinal | longitudinal | |

^a Location of the longitudinal axis of the test piece with respect to the principal rolling direction.
^b The test piece shall comply with ISO 6892-1.
^c The longitudinal axis of the notch shall be perpendicular to the rolled surface.
^d If agreed at the time of ordering, the test piece from products with a thickness exceeding 40 mm may be taken from 1/4 product thickness.

Key

- 1 rolled surface
- 2 alternatives

Figure 4 — Location of the test piece from flat products in relation to product thickness and principal direction of rolling

Annex A (normative)

Ruling sections for mechanical properties

A.1 Definition

See 3.1.

A.2 Determination of the diameter of the equivalent ruling section

A.2.1 If the test pieces are taken from products with simple cross-sections and from positions with quasi-two-dimensional heat flow, A.2.1.1 to A.2.1.3 shall apply.

A.2.1.1 For rounds, the nominal diameter of the product (not comprising the machining allowance) shall be taken as the diameter of the ruling section.

A.2.1.2 For hexagons and octagons, the nominal distance between two opposite sides of the cross-section shall be taken as the diameter of the ruling section.

A.2.1.3 For square and rectangular bars, the diameter of the ruling section shall be determined in accordance with the example shown in Figure A.1.

Dimensions in millimetres

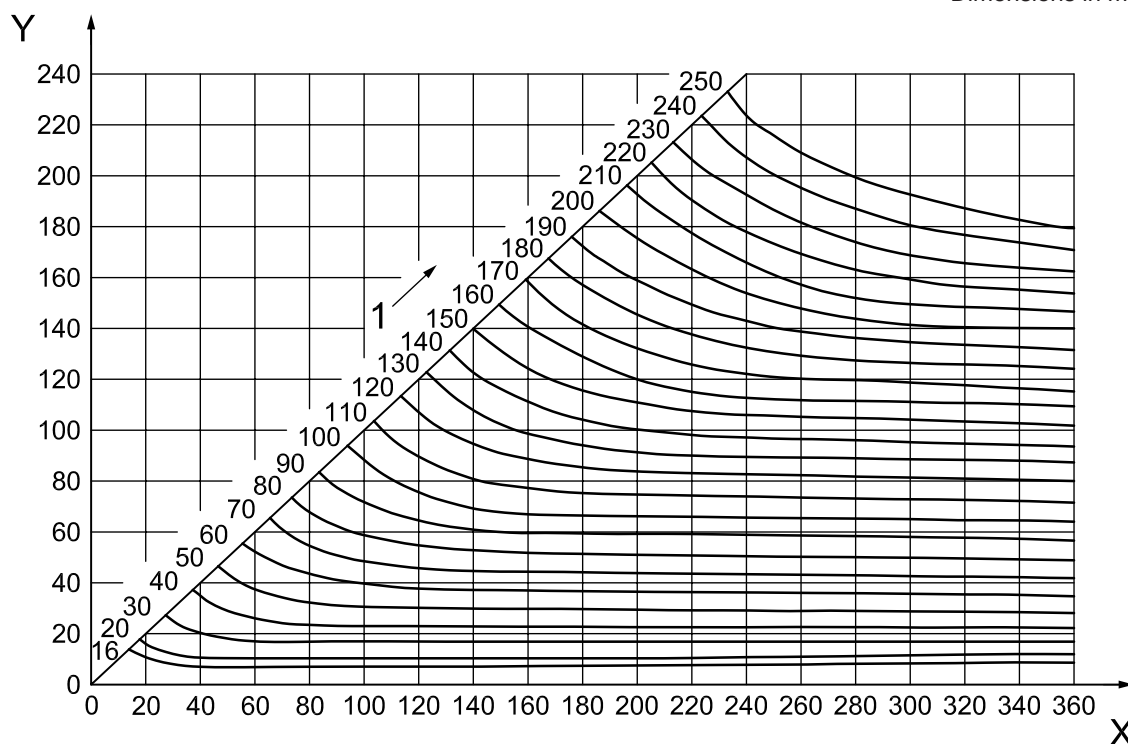
**Key**

- X width
- Y thickness
- 1 diameter of the ruling cross section

EXAMPLE For a rectangular bar with a section of 40 mm × 60 mm, the diameter of the ruling section is 50 mm.

Figure A.1 — Diameter of the equivalent ruling section for square and rectangular sections for quenching in oil or water

A.2.2 For other product forms, the ruling section shall be agreed at the time of enquiry and order.

NOTE For this purpose, the following procedure can serve as a guideline. The product is hardened in accordance with usual practice. It is then cut so that the hardness and structure at the position of the ruling section provided for taking test pieces can be determined. From another product of the type under consideration and of the same cast, an end quench piece is taken from the prescribed position and tested in the usual way. Then, the distance is determined at which the end quench test piece shows the same hardness and structure as the ruling section at the position provided for taking test pieces. On the basis of this distance, the diameter of the ruling section is then estimated using Figure A.2 and Figure A.3.

Dimensions in millimetres

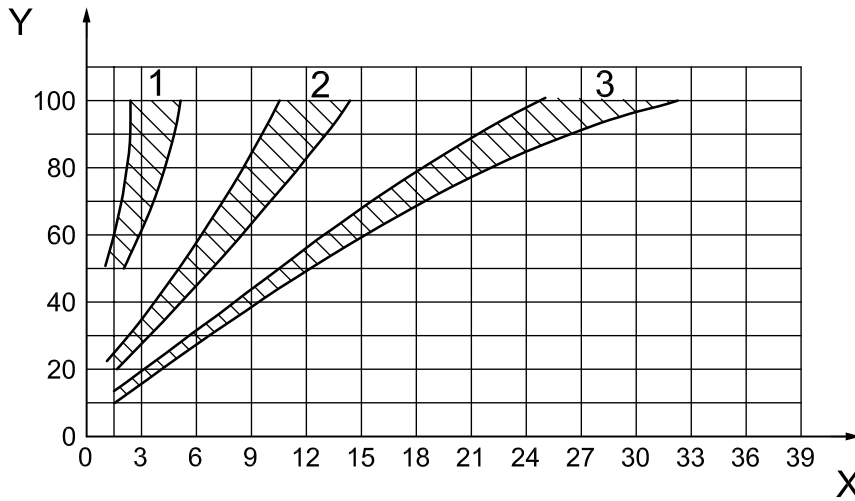

Key

- X distance from the quenched end
- Y bar diameter
- 1 surface
- 2 three-quarter radius
- 3 centre

Figure A.2 — Relationship between the cooling rates in end quench test pieces (Jominy test pieces) and in quenched round bars in mildly agitated water (source: SAE J 406C)

Dimensions in millimetres

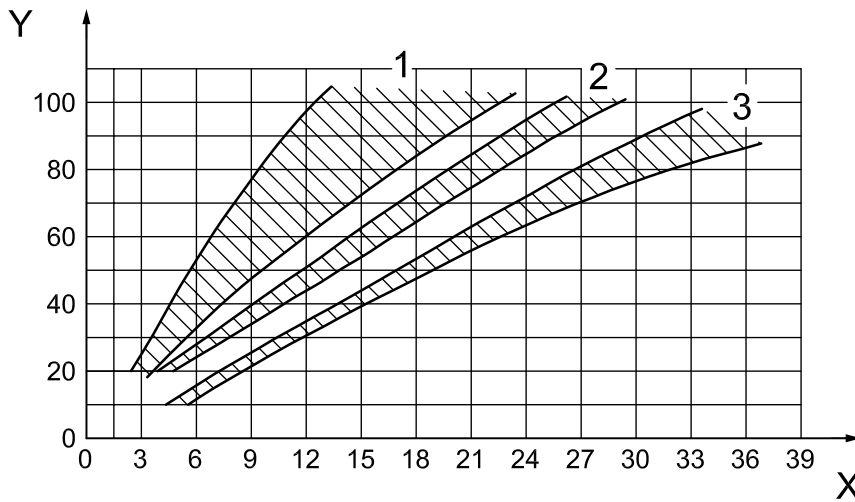

Key

- X distance from the quenched end
- Y bar diameter
- 1 surface
- 2 three-quarter radius
- 3 centre

Figure A.3 — Relationship between the cooling rates in end quench test pieces (Jominy test pieces) and in quenched round bars in mildly agitated oil (source: SAE J 406C)

Annex B (normative)

Supplementary or special requirements

NOTE It is intended that one or more of the following supplementary or special requirements be applied, but only where specified in the enquiry and order. It is intended that, where necessary, details of these requirements be agreed upon by the manufacturer and purchaser at the time of enquiry and order.

B.1 Mechanical properties of reference test pieces in the quenched and tempered condition

For deliveries in a condition other than quenched and tempered or normalized, the requirements for the mechanical properties in the quenched and tempered condition shall be verified on a reference test piece.

In the case of bars and rods, the sample to be quenched and tempered shall, unless otherwise agreed, have the cross-section of the product. In all other cases, the dimensions and the manufacture of the sample shall be agreed at the time of enquiry and order, where appropriate, while taking into consideration the indications for the determination of the ruling section given in Annex A. The samples shall be quenched and tempered in accordance with the conditions given in the relevant table for the heat-treatment conditions or as agreed at the time of enquiry and order. The details of the heat treatment shall be given in the inspection document. The test pieces shall, unless otherwise agreed, be taken in accordance with Figure 2 for bars and rods and in accordance with Figures 3 and 4 for flat products.

B.2 Fine grain steel

This supplementary requirement concerns only the verification of the fine grain size.

When tested in accordance with ISO 643, the steel shall have an austenite grain size of 5 or finer. If specific testing is ordered, it shall also be agreed whether this grain size requirement is to be verified by determining the aluminium content or micrographically. In the first case, the aluminium content shall also be agreed.

In the second case, one test piece shall be inspected per cast for the determination of the austenitic grain size. Sampling and sample preparation shall be as specified in ISO 643.

Unless otherwise agreed at the time of enquiry and order, the quenched grain size shall be determined. Hardening shall be carried out under the following conditions for the purposes of determining the quenched grain size:

- for steels with a lower carbon content limit $< 0,35 \%$: $(880 \pm 10) \text{ }^\circ\text{C}$, 90 min/water;
- for steels with a lower carbon content limit $\geq 0,35 \%$: $(850 \pm 10) \text{ }^\circ\text{C}$, 90 min/water.

In cases of dispute, pretreatment at $1\ 150 \text{ }^\circ\text{C}$ for 30 min/air shall be carried out in order to produce a uniform starting condition.

B.3 Non-destructive tests

The products shall be non-destructively tested under conditions and to an acceptance standard agreed at the time of enquiry and order.

B.4 Product analysis

One product analysis shall be carried out per cast for the determination of all elements for which values are specified for the cast analysis of the steel type concerned.

The conditions for sampling shall be in accordance with ISO 14284. In cases of dispute, the analysis shall be carried out, if possible, in accordance with a reference method taken from one of the International Standards listed in ISO/TR 9769.

B.5 Reduction ratio and deformation ratio

If the central soundness of the hot-rolled or forged products is important, the purchaser shall be aware that a minimum reduction ratio (referred to the cross-section) for long products or a minimum thickness deformation ratio (referred to the thickness) for flat products is necessary. In this case, a minimum reduction ratio or a minimum thickness deformation ratio of e.g. 4:1 may be agreed at the time of enquiry and order.

B.6 Special agreements for marking

The products shall be marked in a way specially agreed at the time of enquiry and order.

.....

Annex C (informative)

Designation of steels given in this part of ISO 683 and of comparable grades covered in various designation systems

Table C.1 — Designation of steels given in this part of ISO 683 and of comparable grades covered in various designation systems

| ISO name (ISO 683-2) | ISO number (ISO 683-2) | Steel designations according to ^a | | | | | | | | |
|-------------------------|---------------------------|----------------------------------------------|--------------------|----------------------------------------|--------------------|---|--------------------|---|-----------------------------------|---|
| | | ASTM Xxxx/UNS ^b | | EN 10083-3:2006 number ^c | | | JIS ^d | | GB/Xxxx/ 200x/ISC ^e | |
| | | – | i/n/w ^f | – | i/n/w ^f | – | i/n/w ^f | – | i/n/w ^f | |
| Steels without boron | | | | | | | | | | |
| 34Cr4 | – | – | – | 34Cr4 | 1.7033 | n | SCr435/ SCr435H | n | – | – |
| 34CrS4 | – | – | – | 34CrS4 | 1.7037 | n | – | – | – | – |
| 37Cr4 | – | – | – | 37Cr4 | 1.7034 | n | – | – | – | – |
| 37CrS4 | – | – | – | 37CrS4 | 1.7038 | n | – | – | – | – |
| 41Cr4 | – | – | – | 41Cr4 | 1.7035 | n | SCr440 SCr440H | n | – | – |
| 41CrS4 | – | – | – | 41CrS4 | 1.7039 | n | – | – | – | – |
| 25CrMo4 | – | – | – | 25CrMo4 | 1.7218 | n | SCM425/ SCM425H | n | – | – |
| 25CrMoS4 | – | – | – | 25CrMoS4 | 1.7213 | n | – | – | – | – |
| 34CrMo4 | – | – | – | 34CrMo4 | 1.7220 | n | SCM435/ SCM435H | n | – | – |
| 34CrMoS4 | – | – | – | 34CrMoS4 | 1.7226 | n | – | – | – | – |
| 42CrMo4 | – | – | – | 42CrMo4 | 1.7225 | n | SCM440/ SCM440H | n | – | – |
| 42CrMoS4 | – | – | – | 42CrMoS4 | 1.7227 | n | – | – | – | – |
| 50CrMo4 | – | – | – | 50CrMo4 | 1.7228 | n | – | – | – | – |
| 41CrNiMo2 | – | – | – | 41CrNiMo2 | (1.6584) | i | SNCM240 | n | – | – |
| 41CrNiMoS2 | – | – | – | 41CrNiMoS2 | (1.6588) | i | – | – | – | – |
| 51CrV4 | – | – | – | 51CrV4 | 1.8159 | n | – | – | – | – |
| 36CrNiMo4 | – | – | – | 36CrNiMo4 | (1.6511) | i | – | – | – | – |
| 34CrNiMo6 | – | – | – | 34CrNiMo6 | 1.6582 | n | – | – | – | – |
| 30CrNiMo8 | – | – | – | 30CrNiMo8 | 1.6580 | n | – | – | – | – |
| Steels with boron | | | | | | | | | | |
| 20MnB5 | – | – | – | 20MnB5 | 1.5530 | i | SWRCHB620 | n | – | – |
| 30MnB5 | – | – | – | 30MnB5 | 1.5531 | i | – | – | – | – |
| 39MnB5 | – | – | – | 38MnB5 | 1.5532 | i | – | – | – | – |
| 27MnCrB5-2 | – | – | – | 27MnCrB5-2 | 1.7182 | i | – | – | – | – |
| 33MnCrB5-2 | – | – | – | 33MnCrB5-2 | 1.7185 | i | – | – | – | – |

Table C.1 (continued)

| ISO name (ISO 683-2) | ISO number (ISO 683-2) | Steel designations according to ^a | | | | | | | |
|-------------------------------------------------------------------------------------------------------------------------------------------------------------------------------------------------------------------------------------------------------------------------------------------------------------------------------------------------------------------------------------------------------------------------------------------------------------------------------------------------------------------------------------------------------------------------------------------------------------------------------------|---------------------------|----------------------------------------------|--------------------|----------------------------------------|--------------------|------------------|--------------------|-----------------------------------|--------------------|
| | | ASTM Xxxx/UNS ^b | | EN 10083-3:2006 number ^c | | JIS ^d | | GB/Xxxx/ 200x/ISC ^e | |
| | | – | i/n/w ^f | – | i/n/w ^f | – | i/n/w ^f | – | i/n/w ^f |
| 39MnCrB6-2 | – | – | – | 39MnCrB6-2 | 1.7189 | i | – | – | – |
| ^a See the sources in Bibliography. ^b US steel listed in ASTM Xxxx and in UNS; – if the steel number is given in brackets, then the steel has only a UNS number. ^c European steel listed in EN 10083-3:2006 and in the “Stahl-Eisen-Liste”; if the steel number is given in parentheses/brackets, the steel is only listed in the “Stahl-Eisen-Liste”. ^d Japanese Industrial Standard. ^e Chinese National Standard. ^f i = identical steel to ISO steel grade; n = steel grade with closer match of composition, but not identical; w = wider match. | | | | | | | | | |

Annex D (informative)

Dimensional standards applicable to products complying with this part of ISO 683

- a) ISO 1035-1, *Hot-rolled steel bars — Part 1: Dimensions of round bars*
- b) ISO 1035-2, *Hot-rolled steel bars — Part 2: Dimensions of square bars*
- c) ISO 1035-3, *Hot-rolled steel bars — Part 3: Dimensions of flat bars*
- d) ISO 1035-4, *Hot-rolled steel bars — Part 4: Tolerances*
- e) ISO 7452, *Hot-rolled steel plates — Tolerances on dimensions and shape*
- f) ISO 16124, *Steel wire rod — Dimensions and tolerances*
- g) ISO 16160, *Continuously hot-rolled steel sheet products — Dimensional and shape tolerances*

Bibliography

- [1] ISO 683-1, *Heat-treatable steels, alloy steels and free-cutting steels — Part 1: Non alloy steels for quenching and tempering*
- [2] ISO 683-9, *Heat-treatable steels, alloy steels and free-cutting steels — Part 9: Wrought free-cutting steels*
- [3] ISO 683-10, *Heat-treatable steels, alloy steels and free-cutting steels — Part 10: Wrought nitriding steels*
- [4] ISO 683-11, *Heat-treatable steels, alloy steels and free-cutting steels — Part 11: Case-hardening steels*
- [5] ISO 683-14, *Heat-treatable steels, alloy steels and free-cutting steels — Part 14: Hot-rolled steels for quenched and tempered springs*
- [6] ISO 683-18, *Heat-treatable steels, alloy steels and free-cutting steels — Part 18: Bright products of unalloyed and low alloy steels*
- [7] ISO 4954, *Steels for cold heading and cold extruding*
- [8] ISO 4960, *Cold-reduced carbon steel strip with a mass fraction of carbon over 0,25 %*
- [9] EN 10204, *Metallic products — Types of inspection documents*
- [10] EN 10247, *Micrographic examination of the non-metallic inclusion content of steels using standard pictures*
- [11] JIS G 0415, *Steel and steel products — Inspection documents*
- [12] JIS G 0555, *Microscopic testing method for the non-metallic inclusions in steel*
- [13] SAE J 406C, *Methods of Determining Hardenability of Steels*

.....

.....