

Steels for quenching and tempering

Technical delivery conditions

DIN
17 200

Vergütungsstähle; technische Lieferbedingungen

Supersedes November 1984 edition.

In keeping with current practice in standards published by the International Organization for Standardization (ISO), a comma has been used throughout as the decimal marker.

See Explanatory notes for connection with International Standard ISO 683 Part 1 published by the International Organization for Standardization (ISO) and with EURONORM 83-70 published by the European Coal and Steel Community.

The clauses and subclauses marked with a single dot ● give specifications which are to be agreed upon at the time of ordering. The subclauses marked with two dots ●● give specifications which are optional and may be agreed upon at the time of ordering.

1 Field of application

1.1 This standard applies to semi-finished products, e.g. blooms, slabs, billets, hot rolled wire, hot rolled or forged steel bars (round, square, hexagonal, octagonal and flat steel bars), hot rolled wide flats, hot or cold rolled plate, sheet and strip, hammer forgings and drop forgings, made from the steels listed in table 2.

The treatment conditions in which the various product forms concerned can be supplied are shown in table 1, and the possible surface finishes are given in subclause 7.2.2.

Note 1. DIN Standards covering steels which are to meet the same requirements regarding chemical composition as given in table 2, but are supplied in other product forms or other treatment conditions or are intended for particular applications, and also DIN Standards covering similar steels are listed in the "Other relevant standards and documents" clause.

Note 2. Hammer forged semi-finished products, for example blooms, slabs, billets and hammer forged steel bars are referred to in this standard as "semi-finished products" and "steel bars", and not as "hammer forgings and drop forgings".

1.2 In addition to the requirements specified in this standard, the general technical delivery conditions for steel and steel products given in DIN 17 010 shall apply unless otherwise specified in this standard.

2 Concepts

2.1 Steels for quenching and tempering

Steels for quenching and tempering as defined in this standard are structural steels which, on the basis of their chemical composition, are suitable for hardening and which, in the quenched and tempered condition, exhibit good toughness for a given level of tensile strength.

2.2 Product forms

The definitions given in EURONORM 79 shall apply for the product forms.

2.3 Types of heat treatment

The terminology used in DIN 17 014 Part 1 shall apply for the types of heat treatment referred to in this standard.

2.4 Equivalent diameter

The information given in Appendix A shall apply with regard to the equivalent diameter.

3 ● Dimensions, permissible dimensional deviations and deviations of form

The nominal sizes, the permissible dimensional deviations and deviations of form for the products shall be agreed at the time of ordering, reference being made, if possible, to the appropriate dimensional standards (see Appendix B).

4 Masses

The masses of the steels covered by this standard have been calculated taking the density as 7,85 kg/dm³.

5 Designation and ordering

5.1 The standard designation for steel complying with this standard, shall give in the following order:

- the name of product (steel);
- the number of this standard;
- the symbol or material number identifying the steel grade (see table 2)¹⁾;
- where applicable, the symbol indicating compliance with the hardenability requirements as specified in subclause 7.3.4;
- where applicable, the symbol indicating compliance with the more stringent hardenability requirements specified in subclause 7.3.5;
- where applicable, the code letter identifying the treatment condition (see subclause 7.2.1).

¹⁾ *DIN-Normenheft* (DIN Standardization booklet) No. 3 provides information on how the designations and material numbers for steels are formed.

Continued on pages 2 to 41

Example 1:

Steel DIN 17 200 – 34 Cr 4 V

or

Steel DIN 17 200 – 1.7033 V

Example 2:

Steel DIN 17 200 – 34 Cr 4 H G

or

Steel DIN 17 200 – 1.7033 H G

5.2 The specifications given in the relevant dimensional standard shall apply for the standard designation of the products.

5.3 The order shall provide any information necessary for a clear description of the required products including their condition and the test methods to be applied. In cases where the designations as in subclauses 5.1 and 5.2 are not adequate for this purpose, for example in the case of agreements as provided for in the clauses marked with ● and ●●, the necessary information shall be added to these designations.

6 Classification into grades

6.1 Steel grades

6.1.1 This standard distinguishes between unalloyed quality steels and unalloyed and alloy high-grade steels (see EURONORM 20).

High-grade steels are distinguished from quality steels by the following:

- minimum impact values in the quenched and tempered condition (for unalloyed steels only those with an average carbon content of less than 0,50% by mass, i.e. not for Ck 50, Cm 50, Ck 55, Cm 55, Ck 60, Cm 60 steels);
- limiting values of hardenability in the end quench test (for unalloyed steels only those with an average carbon content exceeding 0,30% by mass, i.e. not for Ck 22, Cm 22, Ck 25, Cm 25, Ck 30, Cm 30 steels);
- a more uniform response to heat treatment;
- a limited content of oxidic inclusions;
- lower permitted contents of phosphorus and sulfur.

6.1.2 The group of high-grade steels includes two series of steel grades, one for which only a maximum sulfur content of 0,03% by mass is specified and the other specifying a controlled sulfur content of 0,020 to 0,035% by mass (see table 2).

6.1.3 ● The choice of steel grade is at the purchaser's discretion. In making this choice, he may consult the manufacturer without obligation.

7 Requirements

7.1 Manufacturing process

7.1.1 The steelmaking process, the casting process and the process for shaping the product shall be at the manufacturer's discretion.

●● In special cases, however, an agreement on this may be made at the time of ordering.

7.1.2 The steel shall be killed (not semi-killed).

7.2 Treatment condition and surface finish of material on delivery

7.2.1 ●● Treatment condition

The possible treatment conditions are as listed in table 1. Unless otherwise agreed at the time of ordering, the products shall be supplied in the untreated condition.

Note. Not all materials, product forms and sizes can be supplied in the untreated condition.

7.2.2 ●● Special surface finish

If agreed at the time of ordering, the products shall be provided with one of the following surface finishes:

- hot formed and pickled;
- hot formed and abrasive blasted;
- other surface finishes (in this case the details shall be agreed).

7.2.3 Separation by casts

Within one consignment, the products shall be separated by casts.

7.3 Chemical composition, mechanical properties, maximum hardness and hardenability

Table 1 summarizes the usual combinations of heat treatment conditions of the material on delivery, product forms and requirements regarding chemical composition, mechanical properties, maximum hardness and hardenability. Unless otherwise agreed, the requirements given in column 7 of table 1 shall apply for the relevant heat treatment condition of the material on delivery and the particular product form.

●● For ordering to requirement class H, which only applies to high-grade steels, unless the products are to be supplied in the quenched and tempered condition, the requirements regarding hardenability specified in table 4 shall also apply.

7.3.1 Table 2 shall apply for the chemical composition determined by the cast analysis.

7.3.2 The specifications given in table 3 (see also footnote 3 to table 11) shall apply for the permissible deviations of the limiting values applicable to the cast analysis (see table 2) from the results of the product analysis.

7.3.3 The values specified in tables 7, 8 and 9 shall apply to test pieces in the "quenched and tempered" or "normalized" heat treatment conditions, which have been taken and prepared in accordance with figures 3 or 4 and 5 and table 11 (see also footnote 3 to table 1).

As a guide to the use of the steels, table 13 gives a summary of the minimum yield stress values of steels in the quenched and tempered condition for the various diameter ranges.

7.3.4 The values specified in table 4 for the end quench test can generally be assumed as applying to steels covered by this standard under the test conditions as given in table 11.

●● If the values specified in table 4 are to apply as a requirement, the code letter H shall be added to the symbol or the material number for the steel when ordering.

7.3.5 ●● Narrower hardenability scatterbands may be agreed at the time of ordering, as specified in table 5 and figures 1 g to 1 w and footnotes 1 and 2 to table 4. Where a narrower hardenability scatterband with respect to the upper or lower limiting curve is required, the letters HH or HL shall be appended to the symbol or material number for the steel when ordering.

7.4 Technological properties

7.4.1 Weldability

It is not possible to guarantee without reservation that the steels are suitable for any of the various welding processes because the behaviour of a steel during and after welding depends not only on the material, but also on the dimensions and shape and on the manufacturing and service conditions of the component (see also DIN 8528 Part 1).

7.4.2 Machinability

Where improved machinability is required (for machining), consideration should be given to those steels for which a minimum sulfur content is specified.

●● In cases where condition G, characterized by the maximum hardness values given in table 6, is not adequate for providing satisfactory machinability under the proposed machining conditions, a special heat treatment shall be agreed.

7.4.3 Shearability

7.4.3.1 Under suitable conditions, all steel grades specified in this standard are shearable in the softened condition (G), the unalloyed steels being also shearable in the normalized condition (N).

7.4.3.2 C 45, Ck 45, Cm 45, C 50, Ck 50, Cm 50, C 55, Ck 55, Cm 55, C 60, Ck 60, Cm 60, 28 Mn 6, 32 Cr 2, 32 CrS 2, 38 Cr 2, 38 CrS 2, 46 Cr 2, 46 CrS 2, 28 Cr 4, 28 CrS 4, 34 Cr 4, 34 CrS 4, 37 Cr 4, 37 CrS 4, 41 Cr 4, 41 CrS 4, 25 CrMo 4, 25 CrMoS 4, 34 CrMo 4, 34 CrMoS 4, 42 CrMo 4 and 42 CrMoS 4 steels are also shearable under suitable conditions in the "treated for shearability" condition (C), if they conform to the maximum hardness values specified in table 6.

7.4.3.3 C 22, Ck 22, Cm 22, C 25, Ck 25, Cm 25, C 30, Ck 30, Cm 30, C 35, Ck 35, Cm 35, C 40, Ck 40 and Cm 40 steels are also shearable in the untreated condition under suitable conditions.

In the case of C 45, Ck 45 and Cm 45 steels, for sizes of 80 mm and larger, shearability in the untreated condition can be assumed under suitable conditions.

7.5 ●● Grain size

If "fine grain steel" has been ordered, the grain size indices of the austenite as determined on the basis of DIN 50 601 shall be not less than 5.

7.6 ●● Non-metallic inclusions

If requirements regarding the degree of cleanness (applicable for oxidic non-metallic inclusions) determined microscopically as specified in DIN 50 602 have been agreed when ordering high-grade steels, the values given in table 10 shall apply for the characteristic, *K*, of the particular cast.

7.7 ●● Internal condition

Requirements regarding the internal condition of steel products, based, for example, on non-destructive testing, may be agreed at the time of ordering.

7.8 Surface quality

7.8.1 General

7.8.1.1 The products shall have a smooth surface appropriate to the forming process used. For the requirements regarding the surface quality of sheet and wide flats, the specifications in *Stahl-Eisen-Lieferbedingungen* (Iron and steel delivery conditions) 071 shall apply.

7.8.1.2 Removal of surface defects by welding is permitted only with the approval of the purchaser or his representative.

7.8.2 ●● Permissible depth of cracks and skin decarburization

It may be agreed at the time of ordering that a specified depth of crack and/or depth of skin decarburization shall not be exceeded.

Specification of the permissible crack depth, in the case of steel bars and rods of circular cross section shall be in accordance with *Stahl-Eisen-Lieferbedingungen* 055 (at present at the stage of draft).

7.8.3 ●● Suitability for bright drawing

Suitability for bright drawing may be agreed at the time of ordering in the case of steel bars and rods.

8 Testing

8.1 General

The manufacturer shall inspect the quality of his production in such a manner as he considers appropriate and on his own responsibility, with such measures as he considers suitable, in the light of the requirements specified in clause 7.

●● The issue of a document as specified in DIN 50 049 covering tests of materials carried out at the manufacturing works or by independent inspectors, may be agreed at the time of ordering.

8.2 ●● Materials testing certificates issued by the manufacturing works

8.2.1 If a test report (DIN 50 049 – 2.2) is to be issued in accordance with agreements made at the time of ordering, this report shall specify the results of the cast analysis for all the elements listed in table 2 for the relevant steel grades.

8.2.2 If a manufacturer's test certificate (DIN 50 049 – 2.3) is to be issued, the required tests shall be agreed.

The document shall give the following details:

- the results of the cast analysis for all the elements listed in table 2 for the relevant steel grade;
- the results of the agreed tests;
- if reference test pieces have been tested in the normalized or quenched and tempered condition, the type of heat treatment used.

8.3 Materials testing certificates issued by independent inspectors

●● Such documents shall be issued on the basis of acceptance inspection.

● The required tests or the tests required to comply with official regulations and the appropriate codes of practice shall be agreed.

●● If the acceptance inspection is not to be carried out by the works expert, the body carrying out the acceptance inspection or the expert concerned shall be nominated.

The document shall give the following details:

- the information referred to in subclause 8.2.2, items a to c;
- the mark identifying the inspector.

8.4 Scope of test programme, sampling, preparation of samples and test procedure

8.4.1 Chemical composition, hardness, mechanical properties and hardenability

Where these tests have to be carried out, the test conditions specified in table 11 shall apply.

●● Subsequent testing of the mechanical properties on reference test pieces in the normalized or quenched and tempered condition may be agreed at the time of ordering.

The dimensions of the test pieces to be normalized or quenched and tempered shall be agreed.

8.4.2 ●● Grain size

If verification of the austenite grain size has been agreed at the time of ordering, one test piece per cast shall be tested.

Unless otherwise agreed at the time of ordering, sampling and preparation of the test pieces shall be carried out as described in DIN 50 601, and the quench grain size determined. Unless otherwise agreed at the time of ordering, hardening for determination of the quench grain size shall be carried out as follows:

- in the case of steels with a lower limit of carbon content of less than 0,35%:
heating to $(880 \pm 10)^\circ\text{C}$, for 90 minutes, with subsequent quenching in water;
- in the case of steels with a lower limit of carbon content of not less than 0,35%:
heating to $(850 \pm 10)^\circ\text{C}$, for 90 minutes, with subsequent quenching in water.

In cases of dispute, pretreatment shall be carried out at 1150°C , for 30 minutes, with subsequent cooling in air to produce a standard initial condition.

8.4.3 Non-metallic inclusions

DIN 50 602 shall apply for testing for non-metallic inclusions.

8.4.4 ●● Internal condition

In cases where testing of the products for their internal condition (e.g. by ultrasonics) has been agreed, but the testing procedure has not been specified, the scope of test programme, test conditions and test criteria shall be left to the manufacturer's discretion.

8.4.5 ●● Surface defects

Unless otherwise agreed at the time of ordering, the method of testing products for surface defects, the scope of test programme and the test criteria shall be left to the manufacturer's discretion.

8.4.6 ●● Skin decarburization

Normally, for determining the depth of skin decarburization, sufficient sharp-edged polished sections shall be prepared from products in the as delivered condition, in accordance with DIN 50 192, and etched and examined microscopically. The scope of test programme, unless otherwise agreed at the time of ordering, shall be left to the manufacturer's discretion.

Note. The depth of decarburization for the purposes of this standard is understood to mean the depth of the zone with no carbon plus $\frac{2}{3}$ of the depth of the zone with a reduced carbon content.

8.4.7 ●● Visual examination and dimensional inspection

Unless otherwise agreed at the time of ordering, the procedure for visual examination and dimensional inspection shall be left to the manufacturer's discretion.

8.4.8 Retests

The specifications given in DIN 17 010 shall apply.

9 Marking

9.1 The manufacturer shall mark the products or the bundles or packets, as far as possible in compliance with DIN 1599, so that it is possible to identify the cast, the grade of steel and the source of the consignment.

9.2 If the consignments are to be accompanied by documents covering acceptance inspection, the marking shall additionally include the test piece number and the inspector's mark.

9.3 ●● Any further requirements with regard to the marking of the products may be agreed at the time of ordering.

10 Heat treatment

Guideline values for the temperatures during heat treatment are given in table 12.

Figure 6 gives information on the effect of the tempering temperature on the characteristics determined in the tensile test.

If, in the course of further processing, for example in order to obtain lower internal stresses, it is necessary to cool slowly after tempering, a reduction in the impact values may occur, particularly in steels not containing molybdenum.

11 Complaints

11.1 Under current law, warranty claims may only be raised against defective products if the defects impair their processing and use to a more than negligible extent. This shall apply unless otherwise agreed at the time of ordering.

11.2 It is normal and practical for the purchaser to give the supplier the opportunity to judge whether the complaints are justified, if possible by submitting the product objected to or samples of the products supplied.

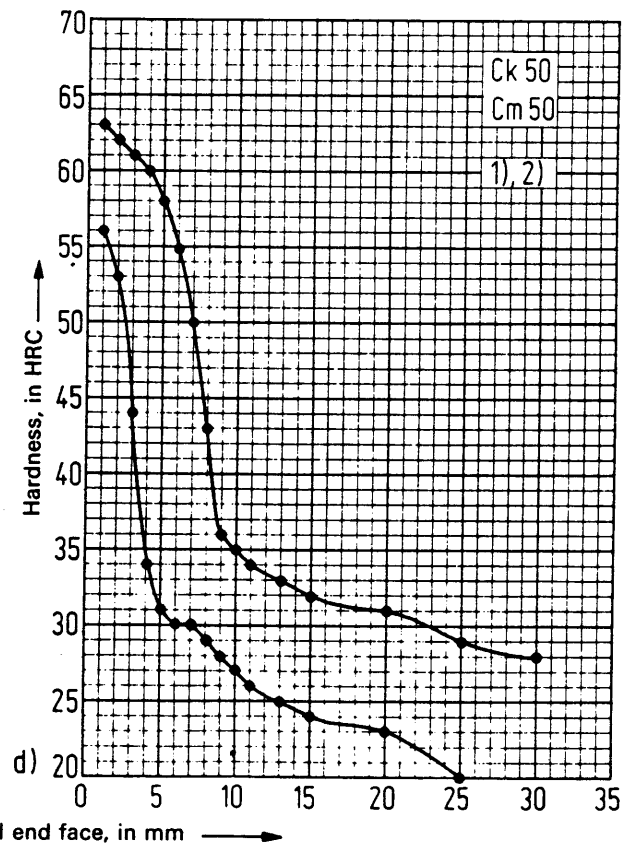
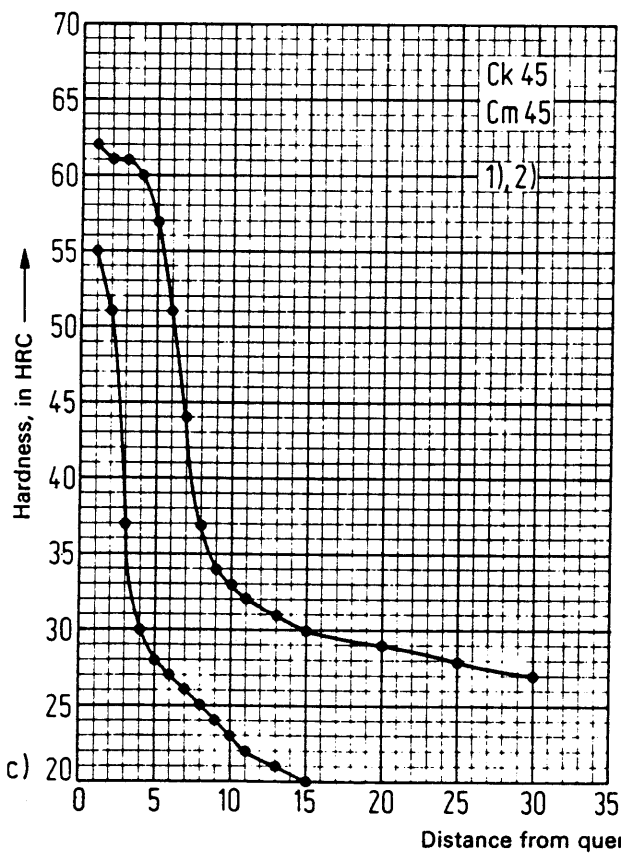
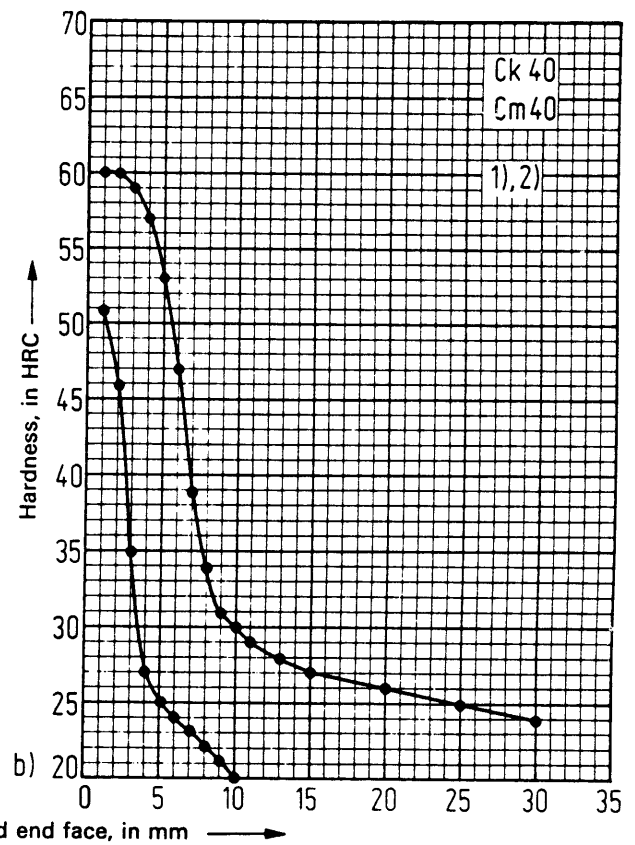
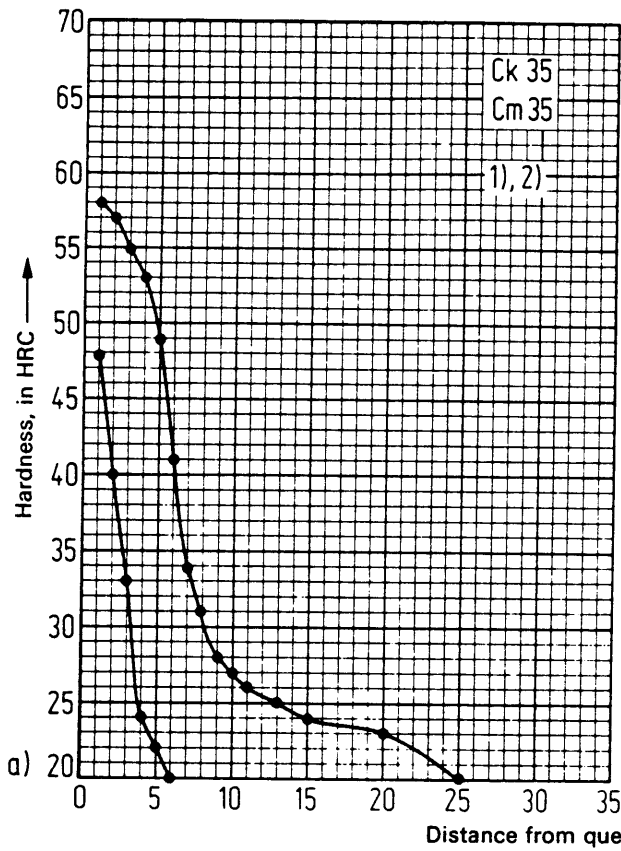
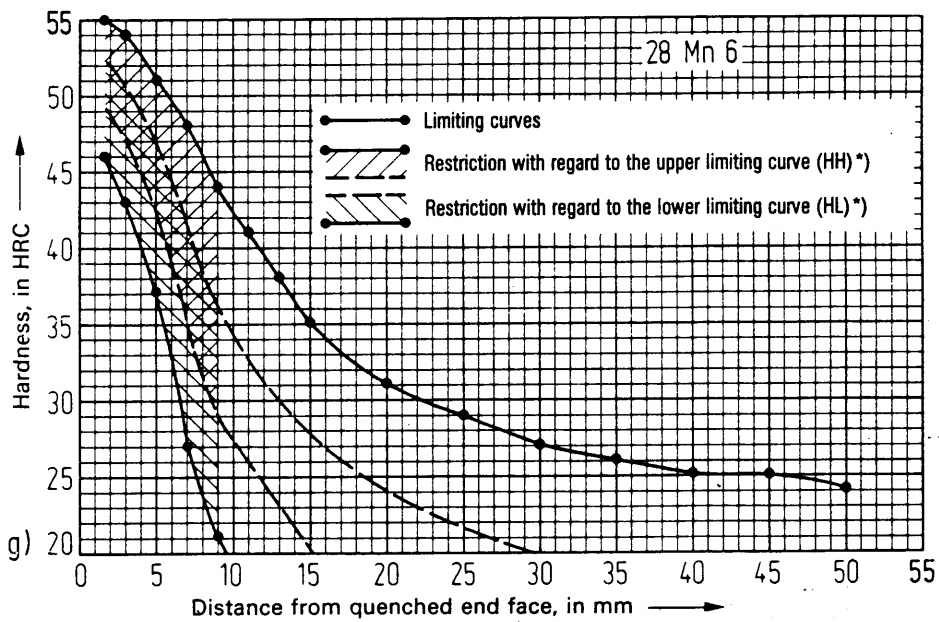
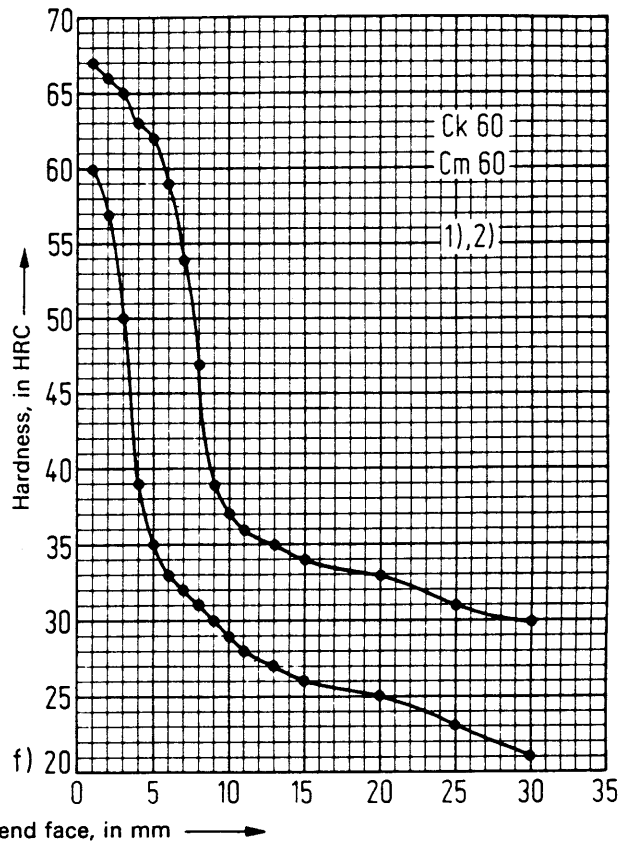
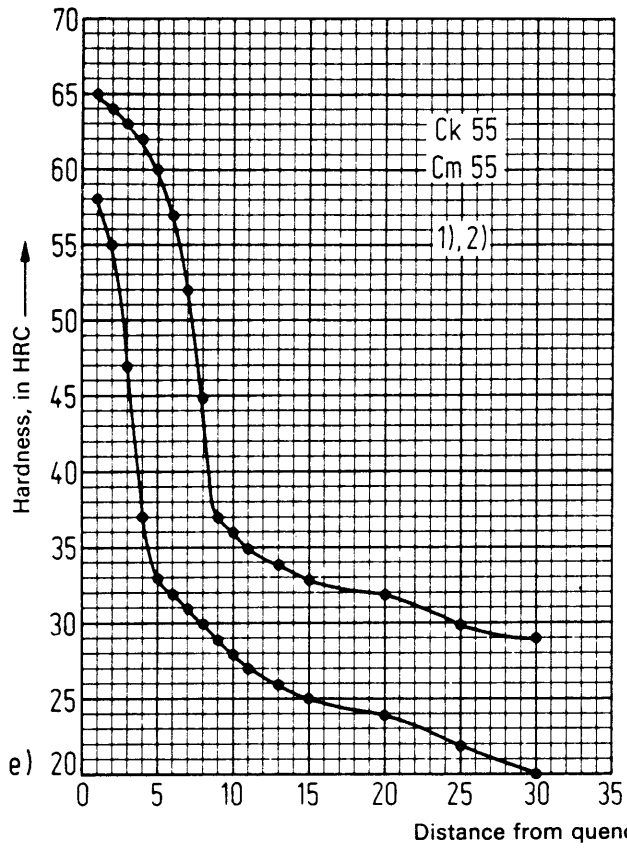

Figure 1. Scatterbands for Rockwell C hardness determined by the end quench test
(The curves shown in figures 1a to 1k are provisional.)

1) See also table 5.

2) It should be noted that, when the hardness test indentations are at 1 mm intervals and with hardness values of less than 30 HRC, there is interaction between the indentations.



*) The restricted hardenability scatterbands shall apply only up to the distance from the quenched end face for which a hardness value has been specified for the lower limiting curve; for greater distances, the restricted scatterbands should be taken for guidance.

For 1) and 2), see page 5.

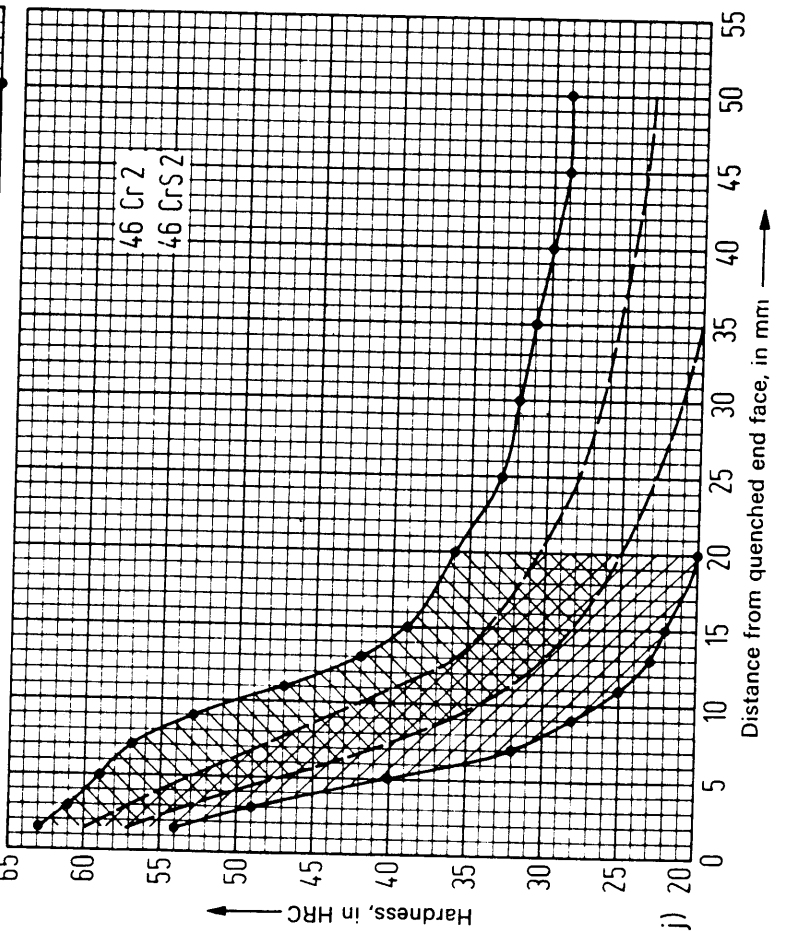
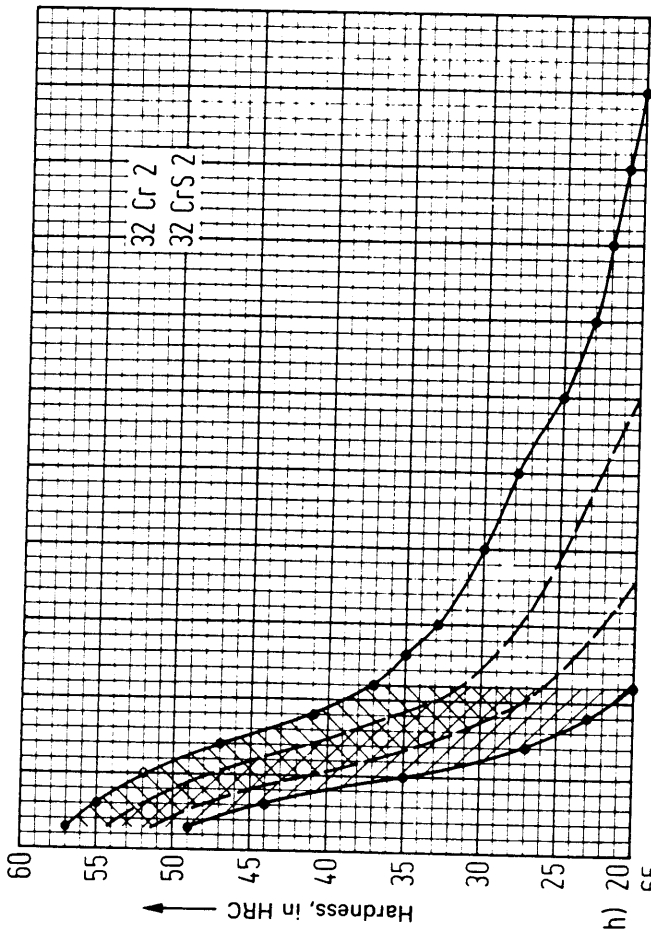
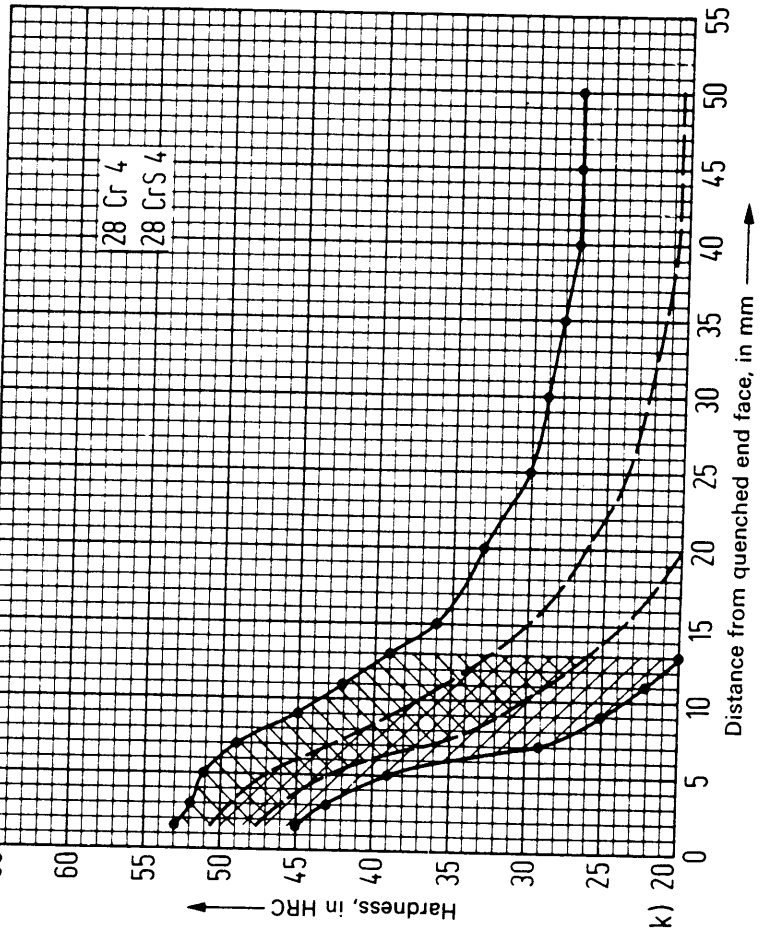
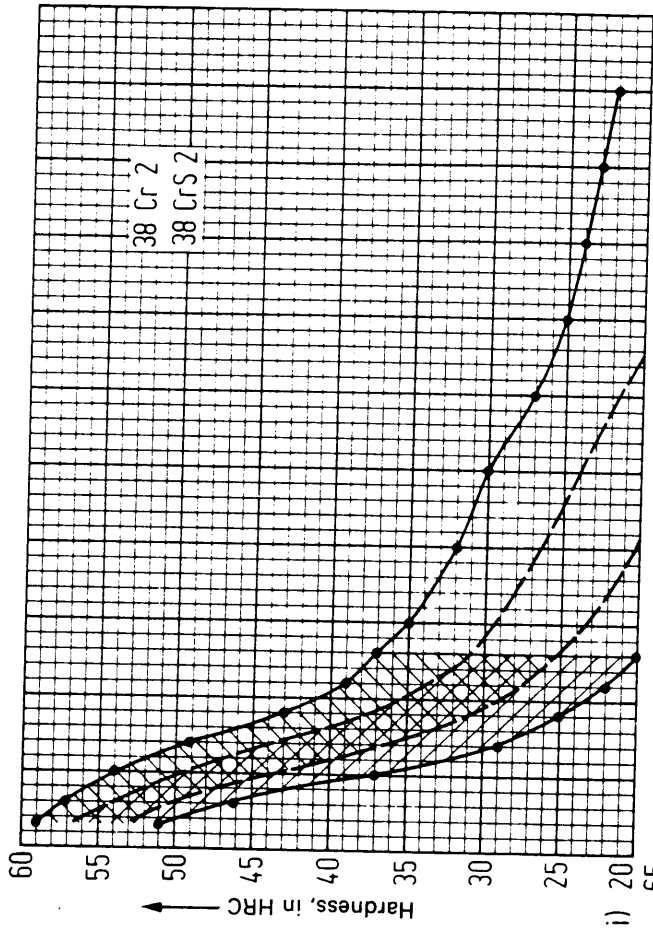

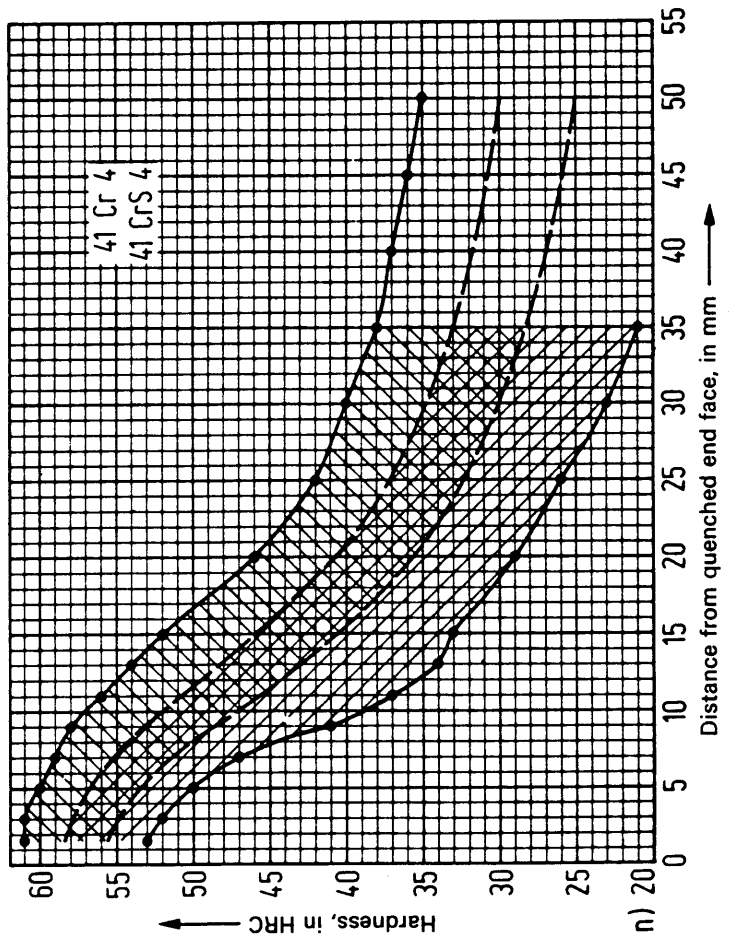
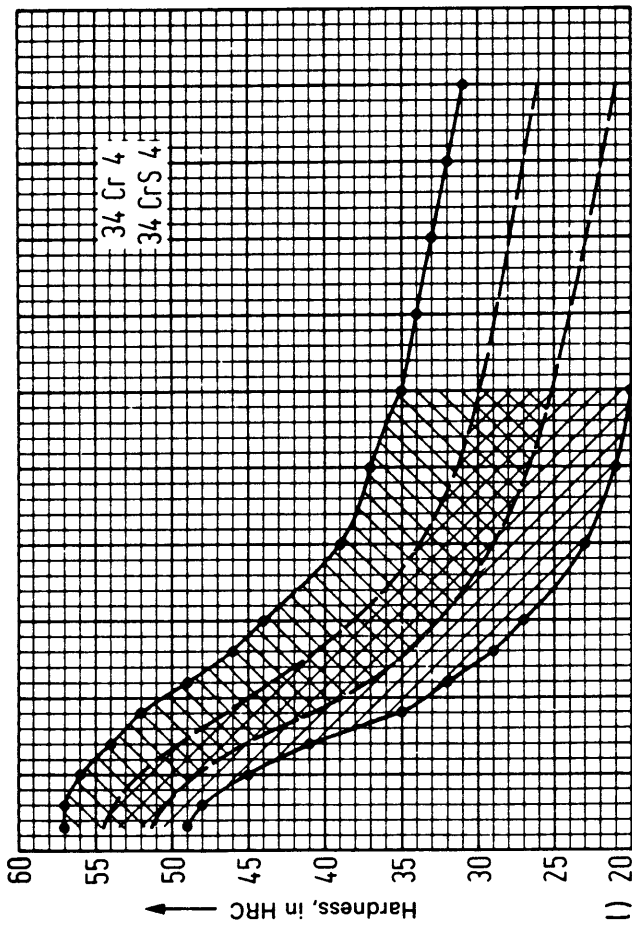
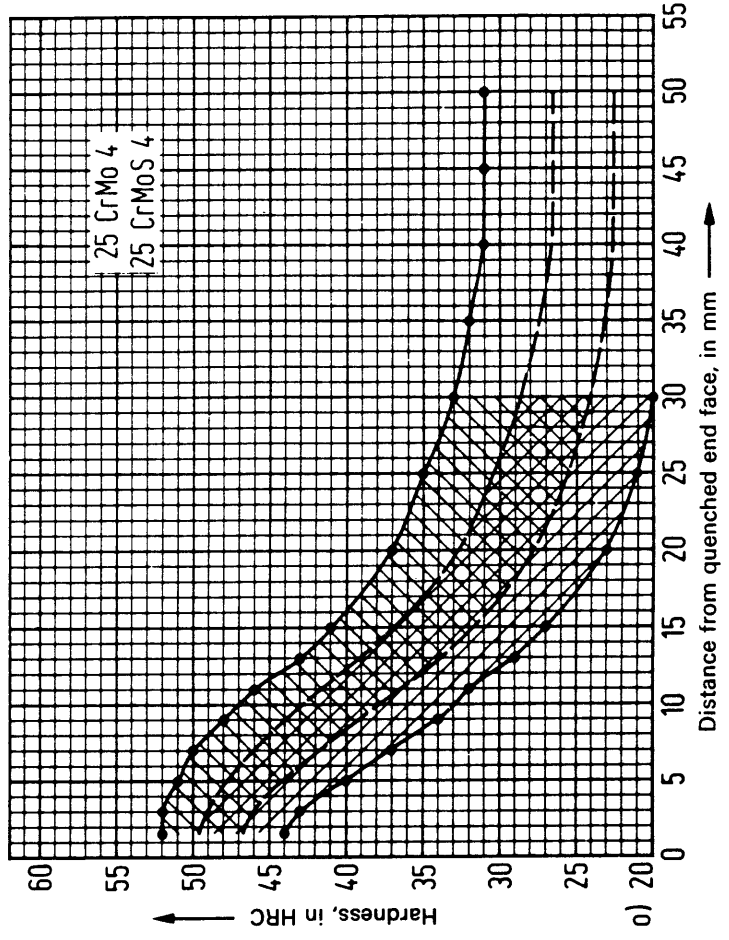
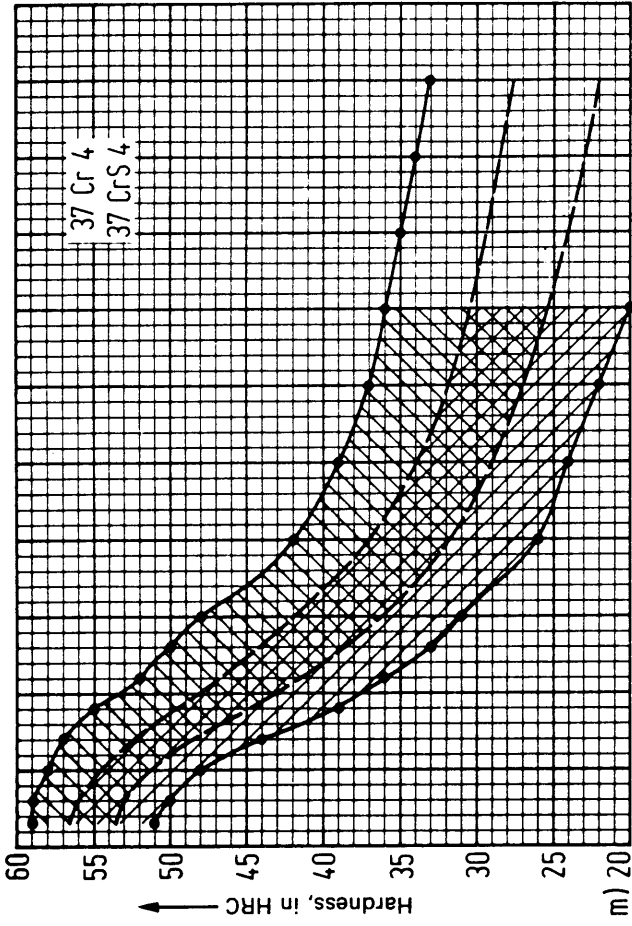

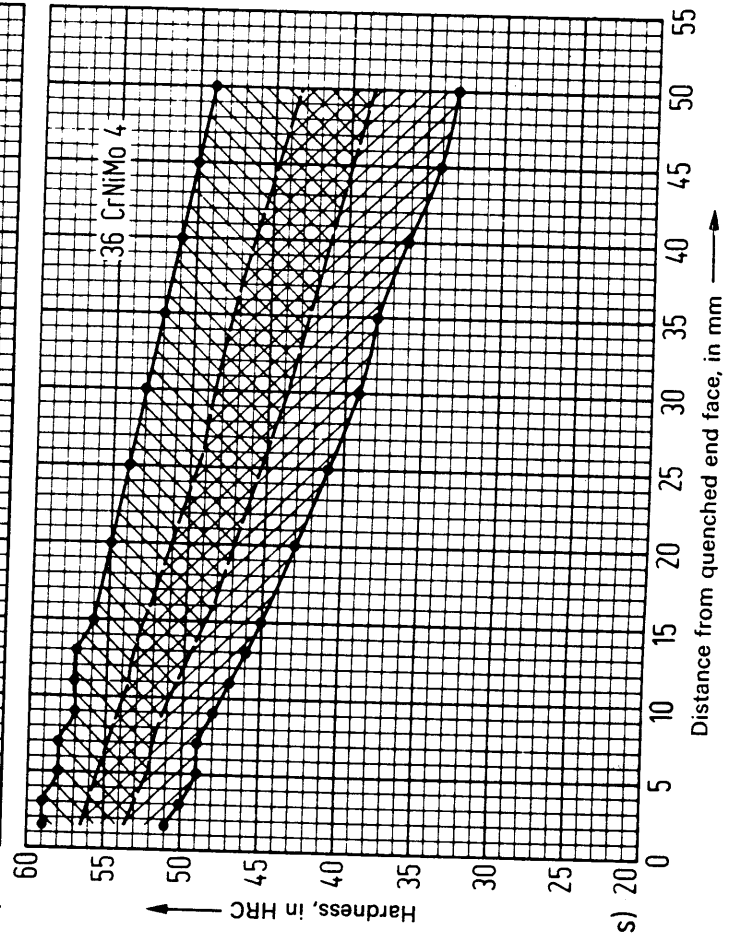
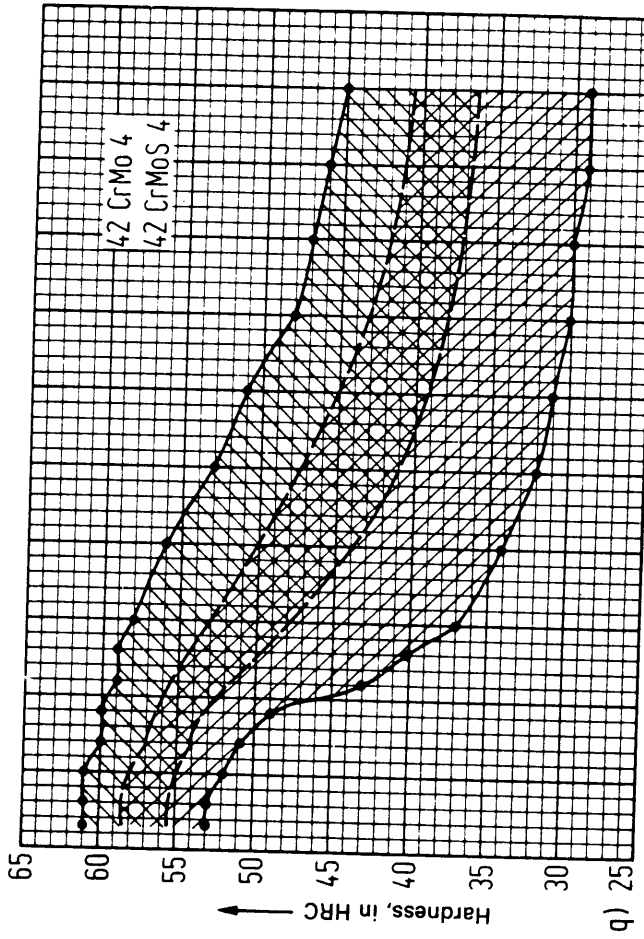
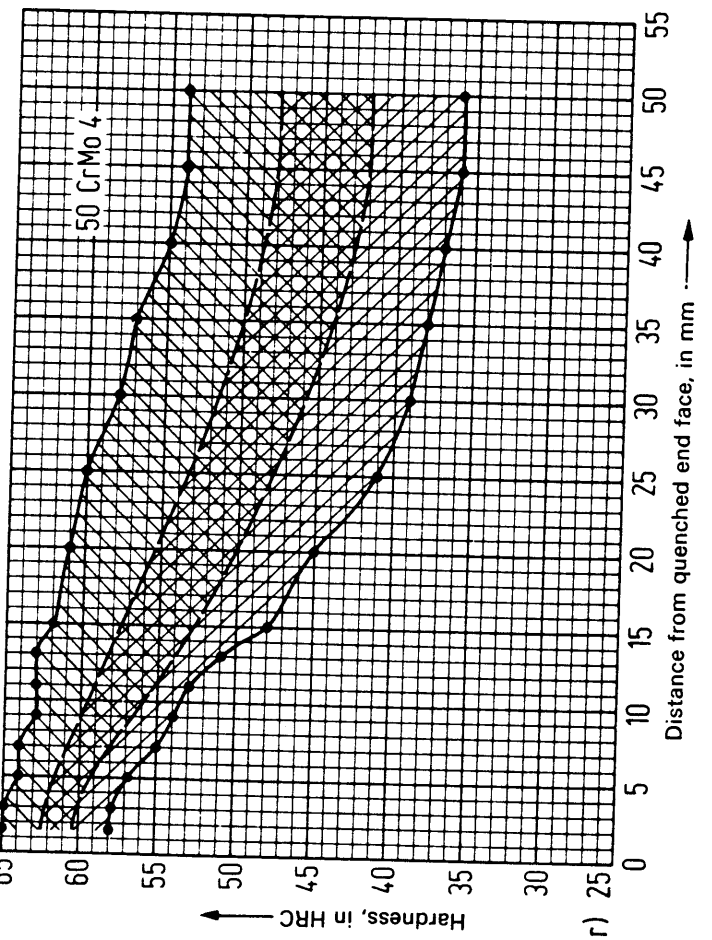
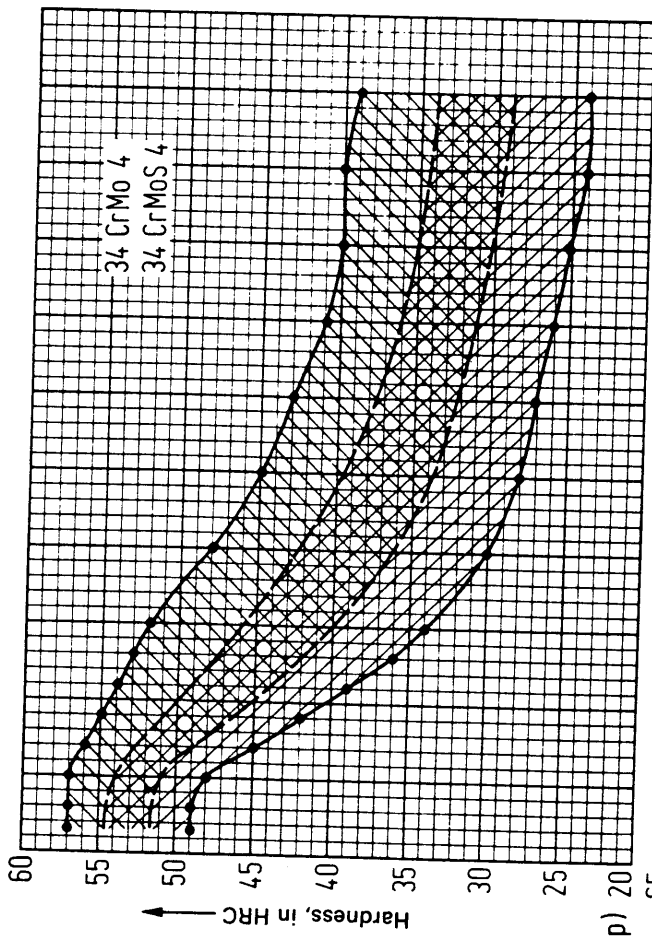

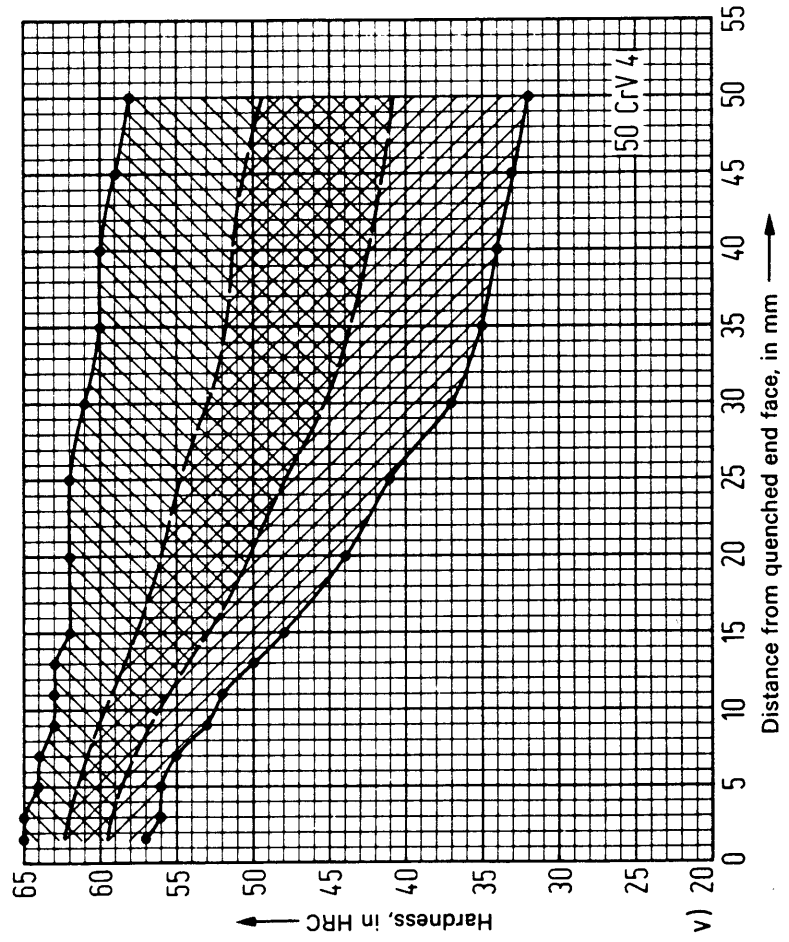
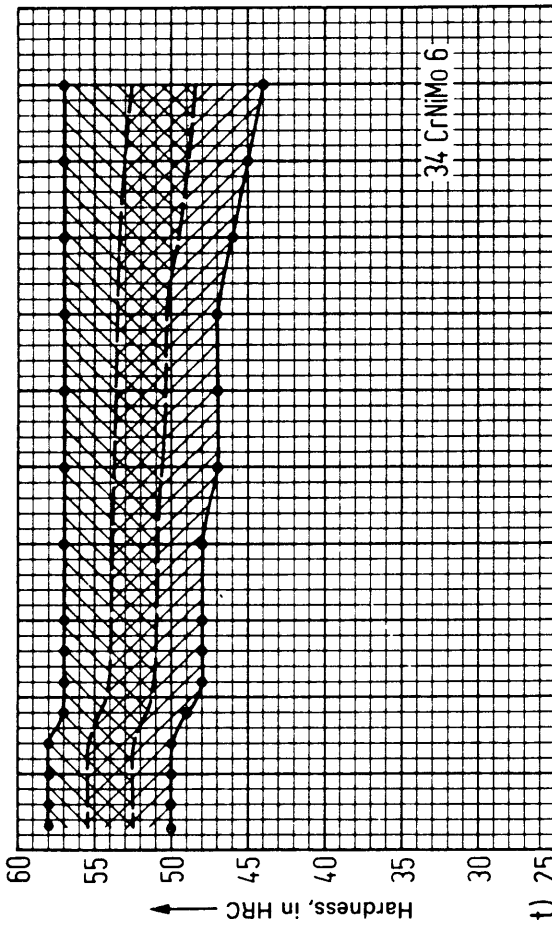
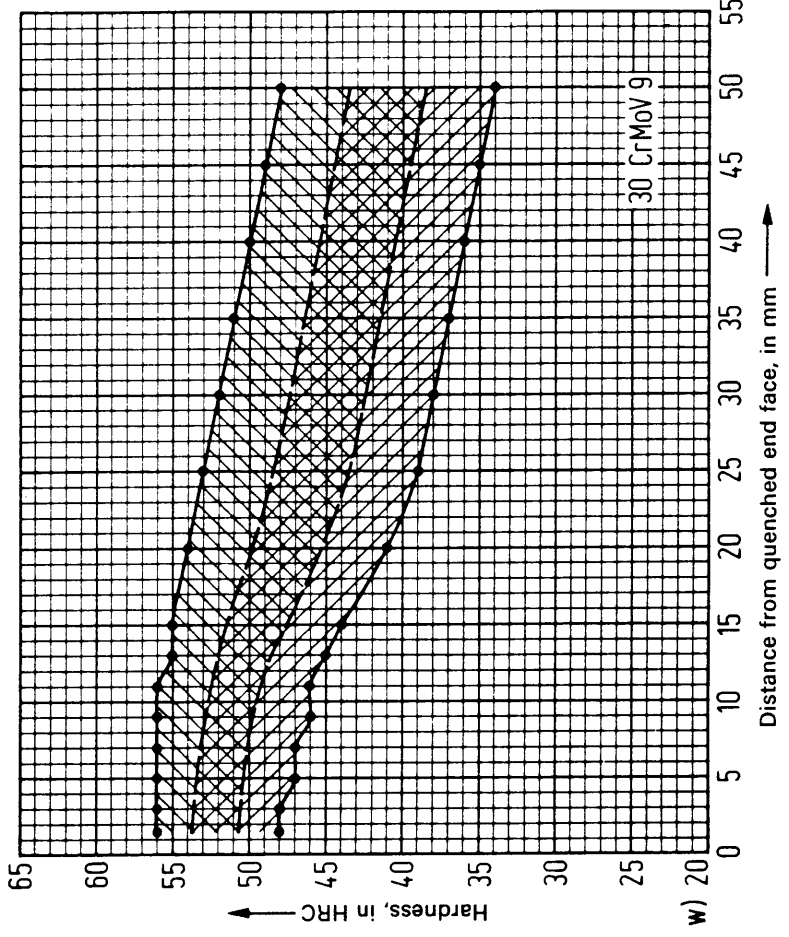
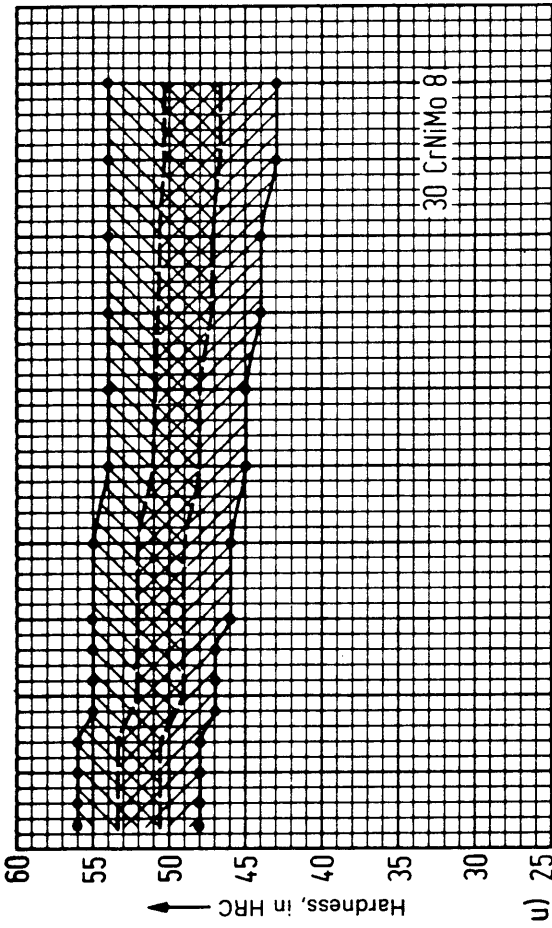

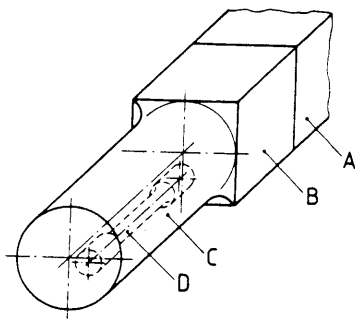

- Sample (A)
- Sample section (B)
- Test bar (C)
- Test piece (D)

(See EURONORM 18 for further explanatory notes.)

Figure 2. Illustration of terms associated with sampling

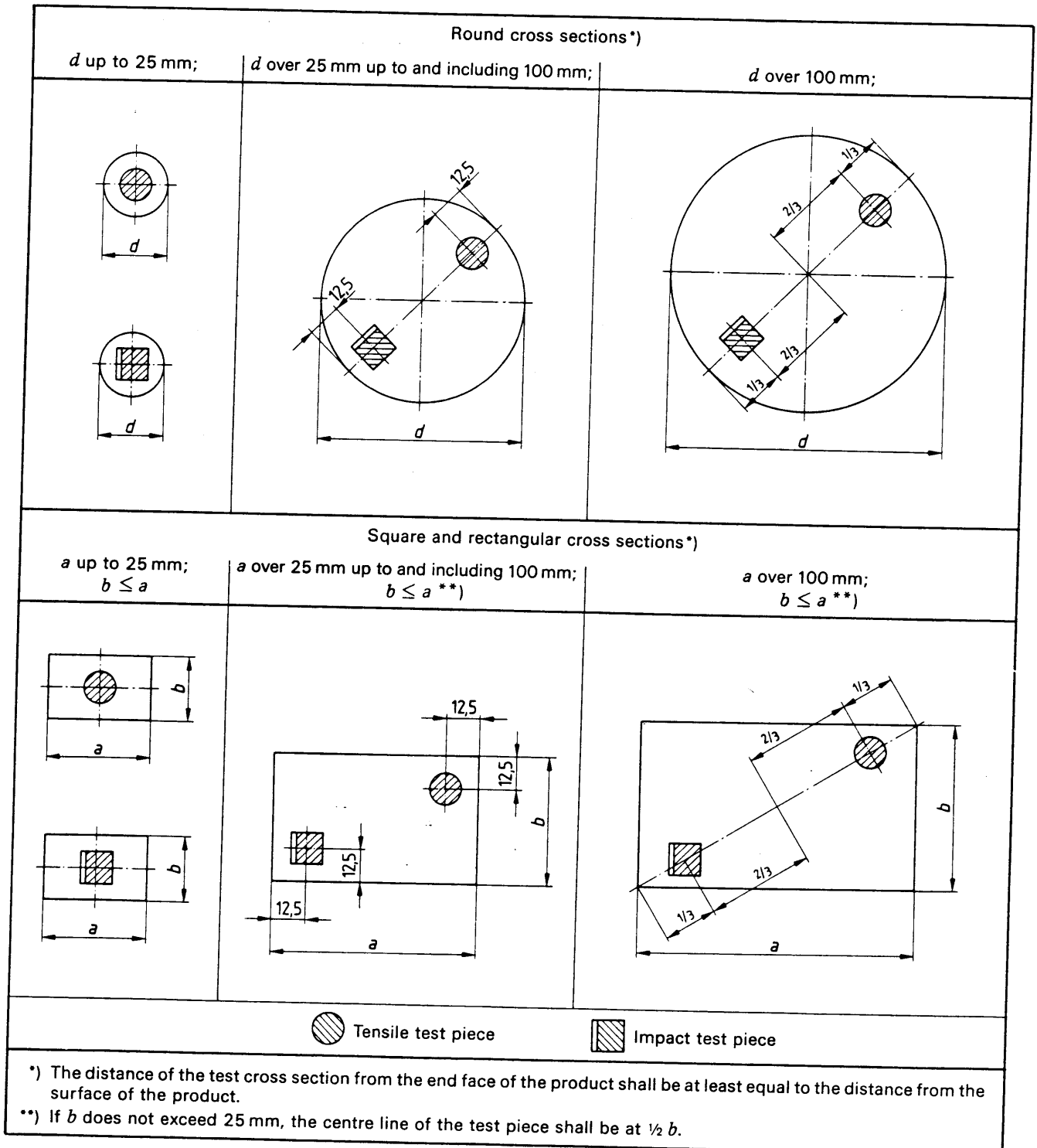

Figure 3. Location of tensile and impact test pieces of round, square and rectangular cross sections

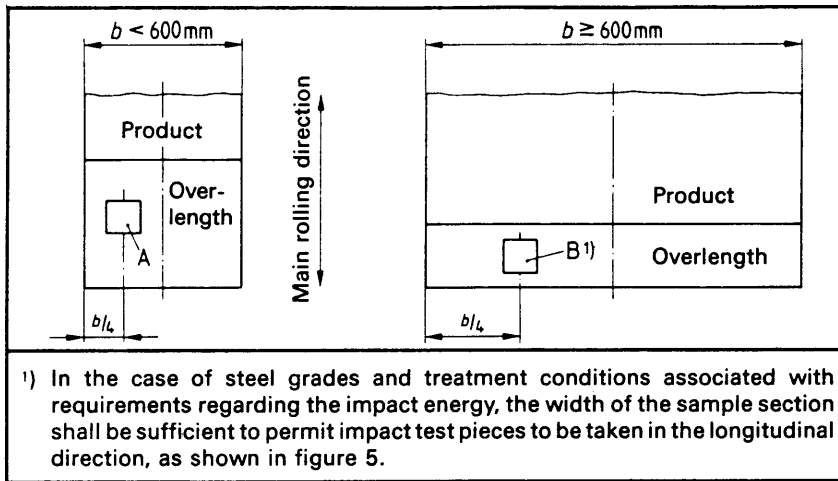

Figure 4. Location of sample sections (A or B) in the case of flat products with width b smaller than 600 mm and b not less than 600 mm

Type of test	Product thickness mm	Position of longitudinal axis of test piece relative to main rolling direction for product widths		Location of test piece relative to unmachined rolling skin mm
		< 600 mm	≥ 600 mm	
Tensile test ¹⁾	≤ 30	Longitudinal	Transverse	
	> 30			
Impact test (notch perpendicular to rolling skin)	> 10	Longitudinal	Transverse	

¹⁾ Round test pieces may also be used at the manufacturer's discretion.

Figure 5. Location of test pieces to be taken from flat products relative to product thickness and main rolling direction

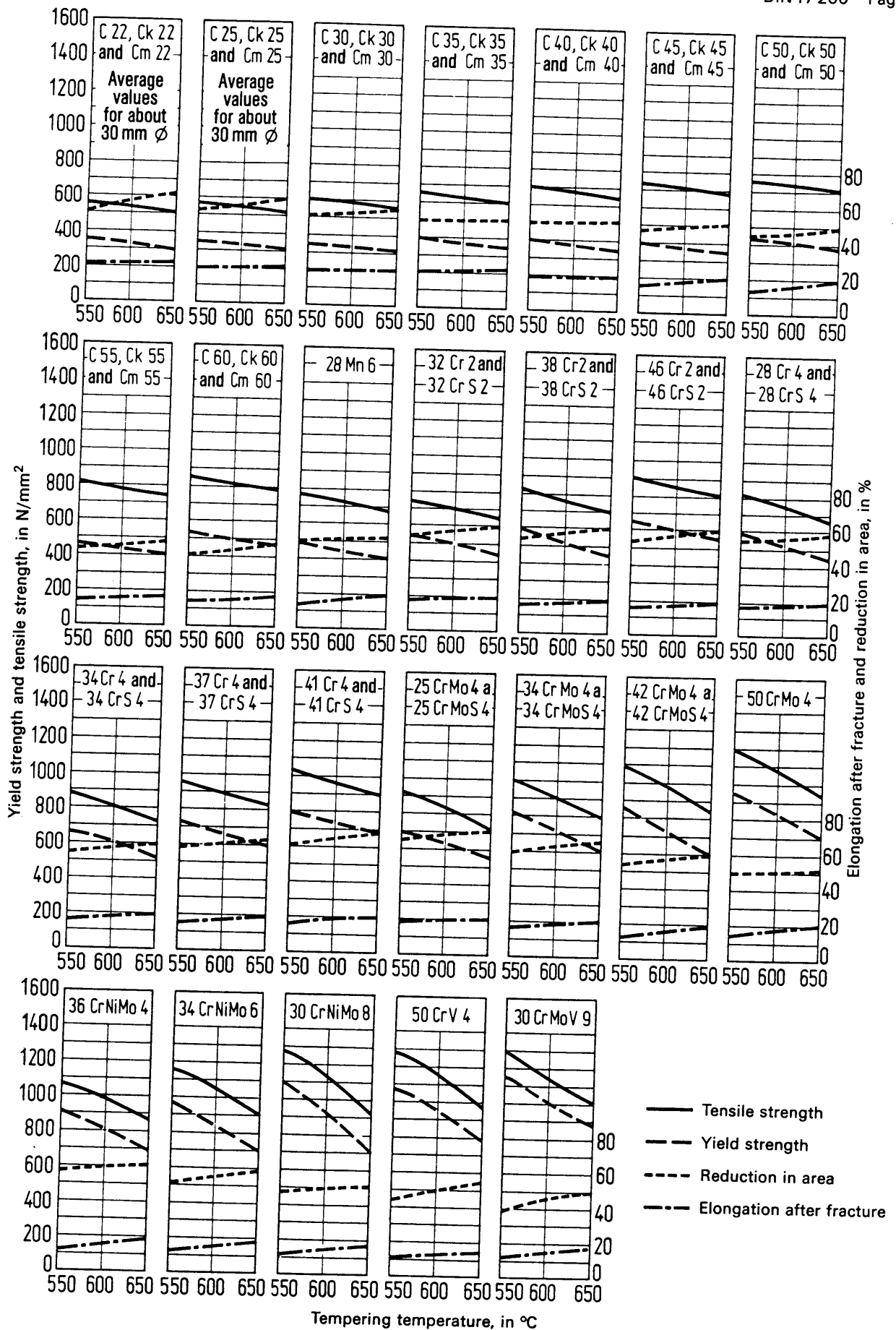

Figure 6. Guideline values showing the influence of the tempering temperature on the characteristics determined in the tensile test (average values for a cross section of about 60 mm in diameter)

Table 1. Heat treatment conditions and product forms in which steels are usually supplied and associated requirement classes as specified in tables 2 to 4 and 6 to 9

No.	1		2	3	4	5	6	7		8				
	Heat treatment condition of material on delivery		Code letter	Form of product				Requirement class						
1			Semi-finished product	Steel bars	Wire rods	Flat products	Hammer forgings and drop forgings	Unless otherwise agreed ¹⁾				H ²⁾ (see subclause 7.3.4)		
2	Untreated		X	X	X	X	X	The following requirements given in tables 2 to 4 and 6 to 9 shall apply:						
3	Treated for shearability		X	X	-	-	-	7.1	7.2	8.1	8.2	8.3		
4	Softened		X	X	X	X	X	Chemical composition as in tables 2 and 3.	Maximum hardness as in	As in columns 7.1 and 7.2.	Hardenability as in table 4.			
5	Normalized		-	X	-	X	table 6, column 3 ³⁾ .				table 6, column 4 ³⁾ .	table 8 or table 9 (depending on product form).		
6	Quenched and tempered		-	X	X	X	Mechanical properties as in				table 7.			-
7			<p>●● If a heat treatment condition other than those in lines 2 to 6 is required, this shall be specified in uncoded form in the order; in such cases, the product form and the requirements shall be agreed at the time of ordering. The "spheroidized" treatment condition (GKZ) as required for cold heading and cold extrusion, is specified in DIN 1654 Part 4.</p>											

1) The hardness values given in table 4 are to be regarded as guideline values in this case (see also subclause 7.3.4).

2) Only applicable for high-grade steels. The code letter H shall be specified in the order.

3) If the products are supplied in the untreated condition, in the "treated for shearability" or "softened" condition, the mechanical properties specified in table 7, 8 or 9 shall be achievable in the relevant end cross section after proper heat treatment.

Table 2. Chemical composition (cast analysis)

Steel grade		% by mass ^{1), 2)}										
Symbol	Material number	C	Si max.	Mn	P max.	S ³⁾	Cr	Mo	Ni	V		
C 22 4), 5)	1.0402 4), 5)	0,17 to 0,24	0,40	0,30 to 0,60	0,045	0,045	-	-	-	-		
Ck 22 4)	1.1151 4)					0,035						
Cm 22 4)	1.1149 4)					0,035						
C 25 5)	1.0406 5)	0,22 to 0,29	0,40	0,40 to 0,70	0,045	0,020 to 0,035	-	-	-	-		
Ck 25	1.1158					0,045						
Cm 25	1.1163					0,035						
C 30 4), 5)	1.0528 4), 5)	0,27 to 0,34	0,40	0,50 to 0,80	0,045	0,020 to 0,035	-	-	-	-		
Ck 30 4)	1.1178 4)					0,045						
Cm 30 4)	1.1179 4)					0,035						
C 35 5)	1.0501 5)	0,32 to 0,39	0,40	0,50 to 0,80	0,045	0,020 to 0,035	-	-	-	-		
Ck 35	1.1181					0,045						
Cm 35	1.1180					0,035						
C 40 4), 5)	1.0511 4), 5)	0,37 to 0,44	0,40	0,50 to 0,80	0,045	0,020 to 0,035	-	-	-	-		
Ck 40 4)	1.1186 4)					0,045						
Cm 40 4)	1.1189 4)					0,035						
C 45 5)	1.0503 5)	0,42 to 0,50	0,40	0,50 to 0,80	0,045	0,020 to 0,035	-	-	-	-		
Ck 45	1.1191					0,045						
Cm 45	1.1201					0,035						
C 50 4), 5)	1.0540 4), 5)	0,47 to 0,55	0,40	0,60 to 0,90	0,045	0,020 to 0,035	-	-	-	-		
Ck 50 4)	1.1206 4)					0,045						
Cm 50 4)	1.1241 4)					0,035						
C 55 4), 5)	1.0535 4), 5)	0,52 to 0,60	0,40	0,60 to 0,90	0,045	0,020 to 0,035	-	-	-	-		
Ck 55 4)	1.1203 4)					0,045						
Cm 55 4)	1.1209 4)					0,035						
C 60 5)	1.0601 5)	0,57 to 0,65	0,40	0,60 to 0,90	0,045	0,020 to 0,035	-	-	-	-		
Ck 60	1.1221					0,045						
Cm 60	1.1223					0,035						

For 1) to 5), see page 16.

Table 2. (continued)

Steel grade		% by mass ^{1), 2)}									
Symbol	Material number	C	Si max.	Mn	P max.	S ³⁾	Cr	Mo	Ni	V	
28 Mn 6	1.1170	0,25 to 0,32	0,40	1,30 to 1,65	0,035	0,03	—	—	—	—	
32 Cr 2	1.7020	0,28 to 0,35	0,40	0,50 to 0,80	0,035	0,03	0,40 to 0,60	—	—	—	
32 CrS 2	1.7021	0,28 to 0,35	0,40	0,50 to 0,80	0,035	0,020 to 0,035	0,40 to 0,60	—	—	—	
38 Cr 2	1.7003	0,35 to 0,42	0,40	0,50 to 0,80	0,035	0,03	0,40 to 0,60	—	—	—	
38 CrS 2	1.7023	0,35 to 0,42	0,40	0,50 to 0,80	0,035	0,020 to 0,035	0,40 to 0,60	—	—	—	
46 Cr 2	1.7006	0,42 to 0,50	0,40	0,50 to 0,80	0,035	0,03	0,40 to 0,60	—	—	—	
46 CrS 2	1.7025	0,42 to 0,50	0,40	0,50 to 0,80	0,035	0,020 to 0,035	0,40 to 0,60	—	—	—	
28 Cr 4	1.7030	0,24 to 0,31	0,40	0,60 to 0,90	0,035	0,03	0,90 to 1,20	—	—	—	
28 CrS 4	1.7036	0,24 to 0,31	0,40	0,60 to 0,90	0,035	0,020 to 0,035	0,90 to 1,20	—	—	—	
34 Cr 4	1.7033	0,30 to 0,37	0,40	0,60 to 0,90	0,035	0,03	0,90 to 1,20	—	—	—	
34 CrS 4	1.7037	0,30 to 0,37	0,40	0,60 to 0,90	0,035	0,020 to 0,035	0,90 to 1,20	—	—	—	
37 Cr 4	1.7034	0,34 to 0,41	0,40	0,60 to 0,90	0,035	0,03	0,90 to 1,20	—	—	—	
37 CrS 4	1.7038	0,34 to 0,41	0,40	0,60 to 0,90	0,035	0,020 to 0,035	0,90 to 1,20	—	—	—	
41 Cr 4	1.7035	0,38 to 0,45	0,40	0,60 to 0,90	0,035	0,03	0,90 to 1,20	—	—	—	
41 CrS 4	1.7039	0,38 to 0,45	0,40	0,60 to 0,90	0,035	0,020 to 0,035	0,90 to 1,20	—	—	—	
25 CrMo 4	1.7218	0,22 to 0,29	0,40	0,60 to 0,90	0,035	0,03	0,90 to 1,20	0,15 to 0,30	—	—	
25 CrMoS 4	1.7213	0,22 to 0,29	0,40	0,60 to 0,90	0,035	0,020 to 0,035	0,90 to 1,20	0,15 to 0,30	—	—	
34 CrMo 4	1.7220	0,30 to 0,37	0,40	0,60 to 0,90	0,035	0,03	0,90 to 1,20	0,15 to 0,30	—	—	
34 CrMoS 4	1.7226	0,30 to 0,37	0,40	0,60 to 0,90	0,035	0,020 to 0,035	0,90 to 1,20	0,15 to 0,30	—	—	
42 CrMo 4	1.7225	0,38 to 0,45	0,40	0,60 to 0,90	0,035	0,03	0,90 to 1,20	0,15 to 0,30	—	—	
42 CrMoS 4	1.7227	0,38 to 0,45	0,40	0,60 to 0,90	0,035	0,020 to 0,035	0,90 to 1,20	0,15 to 0,30	—	—	
50 CrMo 4	1.7228	0,46 to 0,54	0,40	0,50 to 0,80	0,035	0,03	0,90 to 1,20	0,15 to 0,30	—	—	
36 CrNiMo 4	1.6511	0,32 to 0,40	0,40	0,50 to 0,80	0,035	0,03	0,90 to 1,20	0,15 to 0,30	0,90 to 1,20	—	
34 CrNiMo 6	1.6582	0,30 to 0,38	0,40	0,40 to 0,70	0,035	0,03	1,40 to 1,70	0,15 to 0,30	1,40 to 1,70	—	
30 CrNiMo 8	1.6580	0,26 to 0,34	0,40	0,30 to 0,60	0,035	0,03	1,80 to 2,20	0,30 to 0,50	1,80 to 2,20	—	
50 CrV 4	1.8159	0,47 to 0,55	0,40	0,70 to 1,10	0,035	0,03	0,90 to 1,20	—	—	0,10 to 0,20	
30 CrMoV 9	1.7707	0,26 to 0,34	0,40	0,40 to 0,70	0,035	0,03	2,30 to 2,70	0,15 to 0,25	—	0,10 to 0,20	

1) Elements not listed in this table shall not be deliberately added to the steel except for finishing the cast, without the purchaser's approval. In cases of doubt, the limits given in EURONORM 20 shall apply.

2) Except for phosphorus and sulfur, only minor deviations from the limits specified for the cast analysis are permitted, if either restricted hardenability scatterbands in the end quench test (see footnotes 1 and 2 to table 4) or quenched and tempered or normalized products have been ordered and, for this purpose, the values specified in table 7, 8 or 9 are complied with; the deviations shall not exceed the values specified in table 3.

3) In each case the maximum content is given, except where ranges have been specified.

4) These steels are intended only for special applications (in table 2 only, these steels are distinguished by light-face type).

5) ●● This steel may also be ordered with a lead content of 0,15 to 0,30% by mass.

Table 3. Amounts by which the chemical composition in the product analysis may deviate from the limiting values specified for the cast analysis in table 2
(applies to products which, when supplied, have cross sections of up to 10 000 mm² in the case of unalloyed steels or cross sections up to 62 500 mm² in the case of alloy steels)

Element	Maximum permissible content in the cast analysis	Permissible deviations in the product analysis from the limiting values specified for the cast analysis ¹⁾
	% by mass	% by mass
C	$\leq 0,55$ $> 0,55 \leq 0,65$	0,02 0,03
Si	$\leq 0,40$	0,03
Mn	$\leq 1,00$ $> 1,00 \leq 1,65$	0,04 0,05
P	$\leq 0,045$	0,005
S	$\leq 0,045$	0,005
Cr	$\leq 2,00$ $> 2,00 \leq 2,70$	0,05 0,10
Mo	$\leq 0,30$ $> 0,30 \leq 0,50$	0,03 0,04
Ni	$\leq 2,00$ $> 2,00 \leq 2,20$	0,05 0,07
V	$\leq 0,20$	0,02

¹⁾ If several product analyses are to be carried out, the deviations shown by an element within one cast shall lie either only above the upper limit or below the lower limit of the range specified for the cast analysis.

Table 4. Limiting values of Rockwell C hardness determined in the end quench test¹⁾, ²⁾, ³⁾ and ⁴⁾
(hardness values not given in this table can be obtained from figures 1a to 1w)

Steel grade		Limits of hardenability scatterband	Hardness, in HRC, at a distance from quenched end face, in mm, of															
Symbol	Material number		1	2	3	4	5	6	7	8	9	10	11	13	15	20	25	30
Ck 35 ⁵⁾	1.1181 ⁵⁾	Maximum	58	57	55	53	49	41	34	31	28	27	26	25	24	23	20	—
Cm 35 ⁵⁾	1.1180 ⁵⁾	Minimum	48	40	33	24	22	20	—	—	—	—	—	—	—	—	—	—
Ck 40 ⁵⁾	1.1186 ⁵⁾	Maximum	60	60	59	57	53	47	39	34	31	30	29	28	27	26	25	24
Cm 40 ⁵⁾	1.1189 ⁵⁾	Minimum	51	46	35	27	25	24	23	22	21	20	—	—	—	—	—	—
Ck 45 ⁵⁾	1.1191 ⁵⁾	Maximum	62	61	61	60	57	51	44	37	34	33	32	31	30	29	28	27
Cm 45 ⁵⁾	1.1201 ⁵⁾	Minimum	55	51	37	30	28	27	26	25	24	23	22	21	20	—	—	—
Ck 50 ⁵⁾	1.1206 ⁵⁾	Maximum	63	62	61	60	58	55	50	43	36	35	34	33	32	31	29	28
Cm 50 ⁵⁾	1.1241 ⁵⁾	Minimum	56	53	44	34	31	30	30	29	28	27	26	25	24	23	20	—
Ck 55 ⁵⁾	1.1203 ⁵⁾	Maximum	65	64	63	62	60	57	52	45	37	36	35	34	33	32	30	29
Cm 55 ⁵⁾	1.1209 ⁵⁾	Minimum	58	55	47	37	33	32	31	30	29	28	27	26	25	24	22	20
Ck 60 ⁵⁾	1.1221 ⁵⁾	Maximum	67	66	65	63	62	59	54	47	39	37	36	35	34	33	31	30
Cm 60 ⁵⁾	1.1223 ⁵⁾	Minimum	60	57	50	39	35	33	32	31	30	29	28	27	26	25	23	21

1) ●● For the unalloyed steels (except 28 Mn 6 steel), at the following distances from the quenched end face, a restriction of the hardenability scatterband to $\frac{2}{3}$ width, either from the upper or the lower limiting curve (see table 5) may be agreed:

Ck 35, Cm 35, Ck 40, Cm 40, Ck 45 and Cm 45, at 4 mm;
Ck 50, Cm 50, Ck 55, Cm 55, Ck 60 and Cm 60, at 5 mm.

If necessary, a similar agreement may additionally be made in each case for a distance of 1 mm from the end face.

If a restriction in the hardenability scatterband with respect to the upper limiting curve is required, the letter symbol HH and the associated distance from the end face, x , i.e. HH 4 or HH 5, shall be specified in the order; if a restriction in the hardenability scatterband with respect to the lower limiting curve is required, the letter symbol HL and the associated distance from the end face, i.e. HL 4 or HL 5, shall be specified in the order. If at the same time the restriction is also to apply at a distance of 1 mm from the end face, the digit 1 shall precede digit 4 or 5, i.e. HL 14 or HL 15.

2) ●● For the alloy steels and steel 28 Mn 6, restricted hardenability scatterbands in comparison with the original scatterband determined in the end quench test, i.e. restricted with respect to the upper limiting curve or the lower limiting curve (see figures 1g to 1w), may be agreed at the time of ordering. If a restriction in the hardenability scatterband with respect to the upper limiting curve is required, the letter symbol HH shall be specified in the order; and if a restriction in the hardenability scatterband with respect to the lower limiting curve is required, the letter symbol HL shall be specified in the order.

3) ●● Within the context of the conditions specified, particular characteristic values for the hardenability in the end quench test may be agreed at the time of ordering.

4) See Explanatory notes.

5) The limiting values of Rockwell C hardness are to be regarded as provisional for this steel.

Table 4. (continued)

Steel grade		Limits of hardenability scatterband	Hardness, in HRC, at a distance from quenched end face, in mm, of														
Symbol	Material number		1,5	3	5	7	9	11	13	15	20	25	30	35	40	45	50
28 Mn 6 ⁵⁾	1.1170 ⁵⁾	Maximum Minimum	55 46	54 43	51 37	48 27	44 21	41 —	38 —	35 —	31 —	29 —	27 —	26 —	25 —	25 —	24 —
32 Cr 2 ⁵⁾ 32 CrS 2 ⁵⁾	1.7020 ⁵⁾ 1.7021 ⁵⁾	Maximum Minimum	57 49	55 44	52 35	47 27	41 23	37 20	35 —	33 —	30 —	28 —	25 —	23 —	22 —	21 —	20 —
38 Cr 2 ⁵⁾ 38 CrS 2 ⁵⁾	1.7003 ⁵⁾ 1.7023 ⁵⁾	Maximum Minimum	59 51	57 46	54 37	49 29	43 25	39 22	37 20	35 —	32 —	30 —	27 —	25 —	24 —	23 —	22 —
46 Cr 2 ⁵⁾ 46 CrS 2 ⁵⁾	1.7006 ⁵⁾ 1.7025 ⁵⁾	Maximum Minimum	63 54	61 49	59 40	57 32	53 28	47 25	42 23	39 22	36 20	33 —	32 —	31 —	30 —	29 —	29 —
28 Cr 4 ⁵⁾ 28 CrS 4 ⁵⁾	1.7030 ⁵⁾ 1.7036 ⁵⁾	Maximum Minimum	53 45	52 43	51 39	49 29	45 25	42 22	39 20	36 —	33 —	30 —	29 —	28 —	27 —	27 —	27 —
34 Cr 4 34 CrS 4	1.7033 1.7037	Maximum Minimum	57 49	57 48	56 45	54 41	52 35	49 32	46 29	44 27	39 23	37 21	35 20	34 —	33 —	32 —	31 —
37 Cr 4 37 CrS 4	1.7034 1.7033	Maximum Minimum	59 51	59 50	58 48	57 44	55 39	52 36	50 33	48 31	42 26	39 24	37 22	36 20	35 —	34 —	33 —
41 Cr 4 41 CrS 4	1.7035 1.7039	Maximum Minimum	61 53	61 52	60 50	59 47	58 41	56 37	54 34	52 33	46 29	42 26	40 23	38 21	37 —	36 —	35 —
25 CrMo 4 25 CrMoS 4	1.7218 1.7213	Maximum Minimum	52 44	52 43	51 40	50 37	48 34	46 32	43 29	41 27	37 23	35 21	33 20	32 —	31 —	31 —	31 —
34 CrMo 4 34 CrMoS 4	1.7220 1.7226	Maximum Minimum	57 49	57 49	57 48	56 45	55 42	54 39	53 36	52 34	48 30	45 28	43 27	41 26	40 25	40 24	39 24
42 CrMo 4 42 CrMoS 4	1.7225 1.7227	Maximum Minimum	61 53	61 53	61 52	60 51	60 49	59 43	59 40	58 37	56 34	53 32	51 31	48 30	47 30	46 29	45 29
50 CrMo 4	1.7228	Maximum Minimum	65 58	65 58	64 57	64 55	63 54	63 53	63 51	62 48	61 45	60 41	58 39	57 38	55 37	54 36	54 36
36 CrNiMo 4	1.6511	Maximum Minimum	59 51	59 50	58 49	58 49	57 48	57 47	57 46	56 45	55 43	54 41	53 39	52 38	51 36	50 34	49 33
34 CrNiMo 6	1.6582	Maximum Minimum	58 50	58 50	58 50	58 50	57 49	57 48	57 48	57 48	57 48	57 47	57 47	57 47	57 46	57 45	57 44
30 CrNiMo 8	1.6580	Maximum Minimum	56 48	56 48	56 48	56 48	55 47	55 47	55 47	55 46	55 46	54 45	54 45	54 44	54 44	54 43	54 43
50 CrV 4	1.8159	Maximum Minimum	65 57	65 56	64 56	64 55	63 53	63 52	63 50	62 48	62 44	62 41	61 37	60 35	60 34	59 33	58 32
30 CrMoV 9	1.7707	Maximum Minimum	56 48	56 48	56 47	56 47	56 46	56 46	55 45	55 44	54 41	53 39	52 38	51 37	50 36	49 35	48 34

⁵⁾ See page 18.

Table 5. Possible restriction of the hardenability scatterbands at one or two distances from the quenched end faces in the case of unalloyed steels¹⁾

Steel grade		Hardness, in HRC, at a distance from quenched end face, in mm, of			Restriction of hardenability scatterband ²⁾
Symbol	Material number	1	4	5	
Ck 35	1.1181	51 to 58	34 to 53	—	HH
Cm 35	1.1180	48 to 55	24 to 43	—	HL
Ck 40	1.1186	54 to 60	37 to 57	—	HH
Cm 40	1.1189	51 to 57	27 to 47	—	HL
Ck 45	1.1191	57 to 62	41 to 60	—	HH
Cm 45	1.1201	55 to 60	30 to 50	—	HL
Ck 50	1.1206	58 to 63	—	40 to 58	HH
Cm 50	1.1241	56 to 61	—	31 to 49	HL
Ck 55	1.1203	60 to 65	—	42 to 60	HH
Cm 55	1.1209	58 to 63	—	33 to 51	HL
Ck 60	1.1221	62 to 67	—	44 to 62	HH
Cm 60	1.1223	60 to 65	—	35 to 53	HL

¹⁾ See also table 4 and figures 1a to 1f.

²⁾ See footnote 1 to table 4.

Table 6. Maximum hardness for products supplied in the "treated for shearability" condition (C) and "softened" condition (G)

Column No.				Column No.			
1	2	3	4	1	2	3	4
Steel grade		Maximum Brinell hardness in the		Steel grade		Maximum Brinell hardness in the	
Symbol	Material number	treated for shearability condition	softened condition	Symbol	Material number	treated for shearability condition	softened condition
C 22 Ck 22 Cm 22	1.0402 1.1151 1.1149	1)	156	46 Cr 2 46 CrS 2	1.7006 1.7025	255	223
C 25 Ck 25 Cm 25	1.0406 1.1158 1.1163	1)	156	28 Cr 4 28 CrS 4	1.7030 1.7036	255	217
C 30 Ck 30 Cm 30	1.0528 1.1178 1.1179	1)	170	34 Cr 4 34 CrS 4	1.7033 1.7037	255	223
C 35 Ck 35 Cm 35	1.0501 1.1181 1.1180	1)	183	37 Cr 4 37 CrS 4	1.7034 1.7038	255	235
C 40 Ck 40 Cm 40	1.0511 1.1186 1.1189	1)	197	41 Cr 4 41 CrS 4	1.7035 1.7039	255 2)	241
C 45 Ck 45 Cm 45	1.0503 1.1191 1.1201	1)	207	25 CrMo 4 25 CrMoS 4	1.7218 1.7213	255	212
C 50 Ck 50 Cm 50	1.0540 1.1206 1.1241	255	217	34 CrMo 4 34 CrMoS 4	1.7220 1.7226	255	223
C 55 Ck 55 Cm 55	1.0535 1.1203 1.1209	255	229	42 CrMo 4 42 CrMoS 4	1.7225 1.7227	255 2)	241
C 60 Ck 60 Cm 60	1.0601 1.1221 1.1223	255 2)	241	50 CrMo 4	1.7228	3)	248
28 Mn 6	1.1170	255	223	36 CrNiMo 4	1.6511	3)	248
32 Cr 2 32 CrS 2	1.7020 1.7021	255	197	34 CrNiMo 6	1.6582	3)	248
38 Cr 2 38 CrS 2	1.7003 1.7023	255	207	30 CrNiMo 8	1.6580	3)	248
				50 CrV 4	1.8159	3)	248
				30 CrMoV 9	1.7707	3)	248

1) See subclause 7.4.3.3.
2) Softening of these steels may be necessary, as a function of the chemical composition and the sizes, particularly when the hardenability scatterband is restricted with respect to the upper limiting curve.
3) ●● In cases where the shearability is of importance, this steel should be ordered in the softened condition.

Table 7. Mechanical properties of steels in the quenched and tempered condition (code letter V)¹⁾

Steel grade		Up to 16 mm diameter ^{2), 3)}						Over 16 up to and including 40 mm diameter ^{2), 3)}					
		Minimum yield strength (0,2% proof stress)	Tensile strength	Minimum elongation after fracture ($L_0 = 5 d_0$)	Minimum reduction in area after fracture	Minimum impact value ⁴⁾		Minimum yield strength (0,2% proof stress)	Tensile strength	Minimum elongation after fracture ($L_0 = 5 d_0$)	Minimum reduction in area after fracture	Minimum impact value ⁴⁾	
Symbol	Material number	N/mm ²	N/mm ²	%	%	(DVM test piece) ⁵⁾	(ISO V-notch test piece)	N/mm ²	N/mm ²	%	%	(DVM test piece) ⁵⁾	(ISO V-notch test piece)
		J						J					
C 22 Ck 22 Cm 22	1.0402 1.1151 1.1149	350	550 to 700	20	40 to 50	— 55 55	(—) (50) (50)	300	500 to 650	22	45 to 50	— 55 55	(—) (50) (50)
C 25 Ck 25 Cm 25	1.0406 1.1158 1.1163	370	550 to 700	19	40 to 45	— 50 50	(—) (45) (45)	320	500 to 650	21	45 to 50	— 50 50	(—) (45) (45)
C 30 Ck 30 Cm 30	1.0528 1.1178 1.1179	400	600 to 750	18	35 to 40	— 45 45	(—) (40) (40)	350	550 to 700	20	40 to 45	— 45 45	(—) (40) (40)
C 35 Ck 35 Cm 35	1.0501 1.1181 1.1180	430	630 to 780	17	35 to 40	— 40 40	(—) (35) (35)	370	600 to 750	19	40 to 45	— 40 40	(—) (35) (35)
C 40 Ck 40 Cm 40	1.0511 1.1186 1.1189	460	650 to 800	16	30 to 35	— 35 35	(—) (30) (30)	400	630 to 780	18	35 to 40	— 35 35	(—) (30) (30)
C 45 Ck 45 Cm 45	1.0503 1.1191 1.1201	500	700 to 850	14	30 to 35	— 30 30	(—) (25) (25)	430	650 to 800	16	35 to 40	— 30 30	(—) (25) (25)
C 50 Ck 50 Cm 50	1.0540 1.1206 1.1241	520	750 to 900	13	25 to 30	—	(—)	460	700 to 850	15	30 to 35	—	(—)
C 55 Ck 55 Cm 55	1.0535 1.1203 1.1209	550	800 to 950	12	25 to 30	—	(—)	500	750 to 900	14	30 to 35	—	(—)
C 60 Ck 60 Cm 60	1.0601 1.1221 1.1223	580	850 to 1000	11	20 to 25	—	(—)	520	800 to 950	13	25 to 30	—	(—)
28 Mn 6	1.1170	590	780 to 930	13	40	40	(35)	490	690 to 840	15	45	45	(40)
32 Cr 2 32 CrS 2	1.7020 1.7021	450	700 to 850	15	40	40	(35)	350	600 to 750	15	45	40	(35)
38 Cr 2 38 CrS 2	1.7003 1.7023	550	800 to 950	14	35	40	(35)	450	700 to 850	15	40	40	(35)
46 Cr 2 46 CrS 2	1.7006 1.7025	650	900 to 1100	12	35	35	(30)	550	800 to 950	14	40	40	(35)
28 Cr 4 28 CrS 4	1.7030 1.7036	650	850 to 1000	12	40	40	(35)	550	750 to 900	14	45	45	(40)
34 Cr 4 34 CrS 4	1.7033 1.7037	700	900 to 1100	11	35	40	(35)	590	800 to 950	14	40	45	(40)
37 Cr 4 37 CrS 4	1.7034 1.7038	750	950 to 1150	11	35	35	(30)	630	850 to 1000	13	40	40	(35)
41 Cr 4 41 CrS 4	1.7035 1.7039	800	1000 to 1200	10	30	35	(30)	660	900 to 1100	12	35	40	(35)

¹⁾ Specification of dimensional limits does not imply that it is permitted to through quench and subsequently temper the steels to achieve a largely martensitic structure up to the specified test piece location. The depth of hardening is obtained from the end quench curves (see figures 1a to 1w).

²⁾ See Appendix A.

³⁾ ●● The values specified here do not automatically apply for rod quenched and tempered in coils and strip quenched and tempered in bundles; they shall be agreed if required.

⁴⁾ See clause 10.

⁵⁾ ●● Except in cases of dispute, unless otherwise agreed at the time of ordering, the requirements regarding impact energy may be tested using ISO V-notch test pieces instead of DVM test pieces. DVM values will no longer be specified in the revised edition of this standard.

⁶⁾ For diameters over 40 up to and including 63 mm.

Table 7. (continued)

Over 40 up to and including 100 mm diameter ²⁾						Over 100 up to and including 160 mm diameter ²⁾						Over 160 up to and including 250 mm diameter ²⁾					
Minimum yield strength (0,2 % proof stress)	Tensile strength	Minimum elongation after fracture ($L_0 = 5 d_0$)	Minimum reduction in area after fracture	Minimum impact value ⁴⁾		Minimum yield strength (0,2 % proof stress)	Tensile strength	Minimum elongation after fracture ($L_0 = 5 d_0$)	Minimum reduction in area after fracture	Minimum impact value ⁴⁾		Minimum yield strength (0,2 % proof stress)	Tensile strength	Minimum elongation after fracture ($L_0 = 5 d_0$)	Minimum reduction in area after fracture	Minimum impact value ⁴⁾	
				(DVM test piece) ⁵⁾	(ISO V-notch test piece)					(DVM test piece) ⁵⁾	(ISO V-notch test piece)					(DVM test piece) ⁵⁾	(ISO V-notch test piece)
N/mm ²	N/mm ²	%	%	J		N/mm ²	N/mm ²	%	%	J		N/mm ²	N/mm ²	%	%	J	
-	-	-	-	-	(-)	-	-	-	-	-	(-)	-	-	-	-	-	(-)
-	-	-	-	-	(-)	-	-	-	-	-	(-)	-	-	-	-	-	(-)
300 ⁶⁾	500 to 650 ⁶⁾	21 ⁶⁾	45 ⁶⁾ 50 ⁶⁾ 50 ⁶⁾	-	(-) (40) ⁶⁾ (40) ⁶⁾	-	-	-	-	-	(-)	-	-	-	-	-	(-)
320	550 to 700	20	45 50 50	-	(-) (35) (35)	-	-	-	-	-	(-)	-	-	-	-	-	(-)
350	600 to 750	19	40 45 45	-	(-) (30) (30)	-	-	-	-	-	(-)	-	-	-	-	-	(-)
370	630 to 780	17	40 45 45	-	(-) (25) (25)	-	-	-	-	-	(-)	-	-	-	-	-	(-)
400	650 to 800	16	35 40 40	-	(-)	-	-	-	-	-	(-)	-	-	-	-	-	(-)
430	700 to 850	15	35 40 40	-	(-)	-	-	-	-	-	(-)	-	-	-	-	-	(-)
450	750 to 900	14	30 35 35	-	(-)	-	-	-	-	-	(-)	-	-	-	-	-	(-)
440	640 to 790	16	50	45	(40)	-	-	-	-	-	(-)	-	-	-	-	-	(-)
300	500 to 650	17	50	40	(35)	-	-	-	-	-	(-)	-	-	-	-	-	(-)
350	600 to 750	17	45	40	(35)	-	-	-	-	-	(-)	-	-	-	-	-	(-)
400	650 to 800	15	45	40	(35)	-	-	-	-	-	(-)	-	-	-	-	-	(-)
410	650 to 800	15	50	50	(45)	-	-	-	-	-	(-)	-	-	-	-	-	(-)
460	700 to 850	15	45	45	(40)	-	-	-	-	-	(-)	-	-	-	-	-	(-)
510	750 to 900	14	40	40	(35)	-	-	-	-	-	(-)	-	-	-	-	-	(-)
560	800 to 950	14	40	40	(35)	-	-	-	-	-	(-)	-	-	-	-	-	(-)

Table 7. (continued)

Steel grade		Up to 16 mm diameter ²⁾ , ³⁾						Over 16 up to and including 40 mm diameter ²⁾ , ³⁾					
		Minimum yield strength (0,2% proof stress)	Tensile strength	Minimum elongation after fracture ($L_0 = 5 d_0$)	Minimum reduction in area after fracture	Minimum impact value ⁴⁾		Minimum yield strength (0,2% proof stress)	Tensile strength	Minimum elongation after fracture ($L_0 = 5 d_0$)	Minimum reduction in area after fracture	Minimum impact value ⁴⁾	
Symbol	Material number	N/mm ²	N/mm ²	%	%	(DVM test piece) ⁵⁾	(ISO V-notch test piece)	N/mm ²	N/mm ²	%	%	(DVM test piece) ⁵⁾	(ISO V-notch test piece)
		J						J					
25 CrMo 4 25 CrMoS 4	1.7218 1.7213	700	900 to 1100	12	50	50	(45)	600	800 to 950	14	55	55	(50)
34 CrMo 4 34 CrMoS 4	1.7220 1.7226	800	1000 to 1200	11	45	40	(35)	650	900 to 1100	12	50	45	(40)
42 CrMo 4 42 CrMoS 4	1.7225 1.7227	900	1100 to 1300	10	40	35	(30)	750	1000 to 1200	11	45	40	(35)
50 CrMo 4	1.7228	900	1100 to 1300	9	40	35	(30)	780	1000 to 1200	10	45	35	(30)
36 CrNiMo 4	1.6511	900	1100 to 1300	10	45	40	(35)	800	1000 to 1200	11	50	45	(40)
34 CrNiMo 6	1.6582	1000	1200 to 1400	9	40	40	(35)	900	1100 to 1300	10	45	50	(45)
30 CrNiMo 8	1.6580	1050	1250 to 1450	9	40	35	(30)	1050	1250 to 1450	9	40	35	(30)
50 CrV 4	1.8159	900	1100 to 1300	9	40	35	(30)	800	1000 to 1200	10	45	35	(30)
30 CrMoV 9	1.7707	1050	1250 to 1450	9	35	25	(25)	1020	1200 to 1450	9	35	30	(25)

For ²⁾ to ⁵⁾, see page 22.

Table 8. Mechanical properties of unalloyed steel long products in the normalized condition

Steel grade		Diameter	Minimum yield strength (0,2% proof stress)	Tensile strength	Minimum elongation after fracture ($L_0 = 5 d_0$)
Symbol	Material number	mm	N/mm ²	N/mm ²	%
C 22 Ck 22	1.0402 1.1151	Over 16 up to 40	235	410 to 520	27
C 35 Ck 35 Cm 35	1.0501 1.1181 1.1180	Over 16 up to 100	275	490 to 640	21
C 45 Ck 45 Cm 45	1.0503 1.1191 1.1201	Over 16 up to 100	335	590 to 740	17
C 55 Ck 55 Cm 55	1.0535 1.1203 1.1209	Over 16 up to 100	360	660 to 830	15
C 60 Ck 60 Cm 60	1.0601 1.1221 1.1223	Over 16 up to 100	380	690 to 880	14

Table 7. (continued)

Over 40 up to and including 100 mm diameter ²⁾						Over 100 up to and including 160 mm diameter ²⁾						Over 160 up to and including 250 mm diameter ²⁾					
Minimum yield strength (0,2% proof stress)	Tensile strength	Minimum elongation after fracture ($L_0 = 5 d_0$)	Minimum reduction in area after fracture	Minimum impact value ⁴⁾		Minimum yield strength (0,2% proof stress)	Tensile strength	Minimum elongation after fracture ($L_0 = 5 d_0$)	Minimum reduction in area after fracture	Minimum impact value ⁴⁾		Minimum yield strength (0,2% proof stress)	Tensile strength	Minimum elongation after fracture ($L_0 = 5 d_0$)	Minimum reduction in area after fracture	Minimum impact value ⁴⁾	
				(DVM test piece) ⁵⁾	(ISO V-notch test piece)					(DVM test piece) ⁵⁾	(ISO V-notch test piece)					(DVM test piece) ⁵⁾	(ISO V-notch test piece)
N/mm ²	N/mm ²	%	%	J		N/mm ²	N/mm ²	%	%	J		N/mm ²	N/mm ²	%	%	J	
450	700 to 850	15	60	55	(50)	400	650 to 800	16	60	50	(45)	—	—	—	—	—	(—)
550	800 to 950	14	55	50	(45)	500	750 to 900	15	55	50	(45)	450	700 to 850	15	60	50	(45)
650	900 to 1100	12	50	40	(35)	550	800 to 950	13	50	40	(35)	500	750 to 900	14	55	40	(35)
700	900 to 1100	12	50	35	(30)	650	850 to 1000	13	50	35	(30)	550	800 to 950	13	50	35	(30)
700	900 to 1100	12	55	50	(45)	600	800 to 950	13	60	50	(45)	550	750 to 900	14	60	50	(45)
800	1000 to 1200	11	50	50	(45)	700	900 to 1100	12	55	50	(45)	600	800 to 950	13	55	50	(45)
900	1100 to 1300	10	45	40	(35)	800	1000 to 1200	11	50	50	(45)	700	900 to 1100	12	50	50	(45)
700	900 to 1100	12	50	35	(30)	650	850 to 1000	13	50	35	(30)	600	800 to 950	13	50	35	(30)
900	1100 to 1300	10	40	35	(30)	800	1000 to 1200	11	45	40	(35)	700	900 to 1100	12	50	50	(45)

Table 9. Mechanical properties of unalloyed steel flat products in the normalized condition

Steel grade		Product thickness mm	Minimum yield strength (0,2% proof stress) N/mm ²	Tensile strength N/mm ²	Minimum elongation after fracture ($L_0 = 5 d_0$) %	
Symbol	Material number				Longitudinal	Transverse
C 22	1.0402	Up to 100	230	400 to 550	27	25
Ck 22	1.1115	Over 100 up to 160	210	380 to 520	25	23
Cm 22	1.1149					
C 25	1.0406	Up to 16	260	420 to 570	25	23
Ck 25	1.1158	Over 16 up to 100	240	420 to 570	25	23
Cm 25	1.1163	Over 100 up to 160	220	400 to 550	23	21
C 30	1.0528	Up to 16	280	450 to 630	23	21
Ck 30	1.1178	Over 16 up to 100	250	450 to 630	23	21
Cm 30	1.1179	Over 100 up to 160	230	430 to 610	21	19
C 35	1.0501	Up to 16	300	480 to 670	21	19
Ck 35	1.1181	Over 16 up to 100	270	480 to 670	21	19
Cm 35	1.1180	Over 100 up to 160	245	460 to 650	19	17
C 40	1.0511	Up to 16	320	530 to 720	19	17
Ck 40	1.1186	Over 16 up to 100	290	530 to 720	19	17
Cm 40	1.1189	Over 100 up to 160	260	510 to 700	17	15
C 45	1.0503	Up to 16	340	580 to 770	17	15
Ck 45	1.1191	Over 16 up to 100	305	580 to 770	17	15
Cm 45	1.1201	Over 100 up to 160	275	560 to 750	15	13
C 50	1.0540	Up to 16	355	600 to 820	16	14
Ck 50	1.1206	Over 16 up to 100	320	600 to 820	16	14
Cm 50	1.1241	Over 100 up to 160	290	580 to 800	14	12
C 55	1.0535	Up to 16	370	630 to 870	15	13
Ck 55	1.1203	Over 16 up to 100	330	630 to 870	15	13
Cm 55	1.1209	Over 100 up to 160	300	610 to 850	13	11
C 60	1.0601	Up to 16	380	650 to 920	14	12
Ck 60	1.1221	Over 16 up to 100	340	650 to 920	14	12
Cm 60	1.1223	Over 100 up to 160	310	630 to 880	12	10

Table 10. Microscopic degree of cleanness of high-grade steels¹⁾
(applies to oxidic non-metallic-inclusion)

Steel bars Diameter d mm	Integrated characteristic K (oxides) for the various casts
$140 < d \leq 200$	$K 4 \leq 50$
$100 < d \leq 140$	$K 4 \leq 45$
$70 < d \leq 100$	$K 4 \leq 40$
$35 < d \leq 70$	$K 4 \leq 35$
$17 < d \leq 35$	$K 3 \leq 40$
$8 < d \leq 17$	$K 3 \leq 30$
$d \leq 8$	$K 2 \leq 35$

¹⁾ See subclause 7.6.

Table 11. Test conditions for verifying compliance with the requirements¹⁾

No.	1		2	3	4	5	6
	Property	See tables	Test unit ²⁾	Number of test pieces per test unit	tests per test piece	Sampling and preparation of samples	Test method to be used
1	Chemical composition	2 and 3	S			The manufacturer shall inform the purchaser of the results of the cast analysis. See footnote 3 as to whether a product analysis is to be carried out.	
2	Hardenability in the end quench test	4 and 5	S	1	1	As described in DIN 50 191. A cast analysis is also permitted.	The test shall be carried out as described in DIN 50 191. The hardening temperature shall conform to the specifications given in table 12. The hardness values shall be determined as specified in DIN 50 103 Part 1, method C.
3	Hardness of products in the C or G conditions	6	S+W	1	1	<p>In cases of dispute, the hardness shall be determined as close as possible to the product surface at the following location:</p> <ul style="list-style-type: none"> - in the case of round bars, at a distance of one diameter from the bar end; - in the case of bars with rectangular or square cross section and in the case of flat products, at a distance of one thickness from one end and 0,25 times the thickness from one longitudinal edge on a wide side of the product. <p>●● If the above specifications cannot be complied with, appropriate agreements shall be made at the time of ordering (for example in the case of hammer forgings or drop forgings).</p> <p>Preparation of samples as described in DIN 50 351.</p>	As described in DIN 50 351.

For ¹⁾ to ³⁾, see page 29.

Table 11. (continued)

No.	1		2	3	4	5	6
	Property	See tables	Test unit ²⁾	Number of test pieces per test unit	tests per test piece	Sampling and preparation of samples	Test method to be used
4 4a	Mechanical properties to be determined on normalized or quenched and tempered reference test pieces	7, 8 and 9	S	1	One tensile test and three impact tests, if values are specified for the relevant steel for this test in table 7.	<p>See illustration in figure 2.</p> <p>In cases where the mechanical properties are to be verified on normalized or quenched and tempered reference test pieces, the reference test pieces shall be prepared or taken as follows.</p> <ul style="list-style-type: none"> - ● In the case of semi-finished products a sample section shall be formed by hot forging or hot rolling to the cross section of test bar agreed at the time of ordering. - In the case of steel bars, the test bar should be cut from a sample section with the original cross section of the product; in the case of rods, this requirement is mandatory. ●● If so agreed at the time of ordering, in the case of steel bars, the sample may be formed to a smaller cross section. - In the case of flat products, a sample section taken as shown in figure 4 is understood to mean the test bar. - In the case of hammer forgings and drop forgings, the test bar shall consist of a part of the forging with the cross section that is significant for the mechanical properties of the forging (hereinafter referred to as ruling section) or, in the case of small forgings, the complete forging shall be tested. <p>The test bars shall be normalized or quenched and tempered in accordance with the details given in table 12.</p> <p>The test pieces shall be taken from the sample sections of flat products as shown in table 5 and from the sample sections of other products as shown in figure 3.</p> <p>The tensile test pieces shall be prepared as described in DIN 50125 and DIN 50145, the impact test pieces as described in DIN 50115.</p>	<p>The tensile test shall be carried out as specified in DIN 50145, using the short proportional bar specified in DIN 50125. If there is no clear yield strength, the 0,2% proof stress shall be determined.</p> <ul style="list-style-type: none"> ● In the case of rods of diameters less than 6 mm, test pieces with a gauge length, L_0, of $10 d_0$ shall be used; the elongation after fracture values to be met in this case shall be agreed at the time of ordering. <p>The impact test shall be carried out on DVM test pieces or ISO V-notch test pieces (see footnote 5 to table 7) as described in DIN 50115.</p> <p>The impact value shall be determined as the average value of three tests on test pieces lying side by side in the same sample and at the same distance from the surface or, if this is impossible or not desirable, immediately behind each other.</p> <p>Only one of three individual values may be below the specified minimum value, provided it is not less than 70% of the value.</p> <p>If, because the product thicknesses are small, the impact values can only be tested on test pieces with a width of less than 10 mm, but not less than 5 mm, the minimum values specified in table 7 shall be reduced in proportion to the test piece cross section.</p>

2) See page 29.

Table 11. (continued)

No.	1		2	3	4	5	6
	Property	See tables	Test unit ²⁾	Number of test pieces per test unit	tests per test piece	Sampling and preparation of samples	Test method to be used
4b	to be determined on quenched and tempered products in the as delivered sizes	7	S+A+W	1	One tensile test and three impact tests, if values are specified for the relevant steel for this test in table 7.	<p>The test pieces for the tensile test and, where necessary, for the impact test shall be taken as follows:</p> <ul style="list-style-type: none"> - in the case of steel bars (including reference test bars of appropriate shape) and rods, as shown in figure 3; - in the case of flat products, in accordance with the specifications in figures 4 and 5; - ● in the case of hammer forgings and drop forgings (including reference test bars of appropriate shape) the test pieces shall be taken from a location on the forging to be agreed at the time of ordering, in such a manner that their longitudinal axis lies in the fibre direction. <p>The tensile test pieces shall be prepared as described in DIN 50125 and DIN 50145 and the impact test pieces as described in DIN 50115.</p>	See No. 4a.
4c	to be determined on normalized products in the as delivered sizes	8 and 9	S+A+W	1	One tensile test	The test pieces for the tensile test shall be taken and prepared in accordance with the details given under No. 4b.	The tensile test shall be carried out as described in DIN 50145, using the short proportional bar specified in DIN 50125. If there is no clear yield strength, the 0,2% proof stress shall be determined.

1) Verification is only necessary if the requirement is specified in table 1, columns 7 and 8, for the requirement class ordered, and the appropriate test has been agreed.

2) S = cast, A = dimensions, W = heat treatment batch.

3) ●● If subsequent checking of the chemical composition on the product has been agreed at the time of ordering, one product analysis shall be carried out per cast. The specifications given in *Stahl-Eisen-Prüfblatt* (Iron and steel test sheet) 1805 shall apply for sampling and preparation of samples. For the analytical procedure, the specifications given in *Handbuch für das Eisenhüttenlaboratorium* (Handbook for the ferrous metallurgy laboratory), volumes 2 and 5 shall apply.

Table 12. Hardening temperatures in the end quench test and guideline values for the heat treatment

Steel grade Symbol	Hardening temperature in the end quench test ¹⁾ °C	Softening at °C	Normalizing at °C	Quenching		Tempering ³⁾ at °C		
				in water ²⁾ at °C	in oil ²⁾ at °C			
C 22, Ck 22, Cm 22	—		880 to 910	860 to 890	—			
C 25, Ck 25, Cm 25	—		880 to 910	860 to 890	—			
C 30, Ck 30, Cm 30	—		870 to 900	850 to 880	—			
C 35, Ck 35, Cm 35	870	650 to 700	860 to 890	840 to 870	850 to 880	540 to 680		
C 40, Ck 40, Cm 40	870		850 to 880	830 to 860	840 to 870			
C 45, Ck 45, Cm 45	850		840 to 870	820 to 850	830 to 860			
C 50, Ck 50, Cm 50	850		835 to 865	810 to 840	820 to 850			
C 55, Ck 55, Cm 55	830		830 to 860	805 to 835	815 to 845			
C 60, Ck 60, Cm 60	830		820 to 850	800 to 830	810 to 840			
28 Mn 6	850		650 to 700	850 to 880	820 to 850		830 to 860	540 to 680
32 Cr 2, 32 CrS 2	850		650 to 700	860 to 890	840 to 870		850 to 880	540 to 680
38 Cr 2, 38 CrS 2		850 to 880		830 to 860	840 to 870			
46 Cr 2, 46 CrS 2		840 to 870		820 to 850	830 to 860			
28 Cr 4, 28 CrS 4	850	680 to 720	860 to 900	840 to 870	850 to 880	540 to 680		
34 Cr 4, 34 CrS 4			850 to 890	830 to 860	840 to 870			
37 Cr 4, 37 CrS 4			845 to 885	825 to 855	835 to 865			
41 Cr 4, 41 CrS 4			840 to 880	820 to 850	830 to 860			
25 CrMo 4, 25 CrMoS 4	860	680 to 720	860 to 900	840 to 870	850 to 880	540 to 680		
34 CrMo 4, 34 CrMoS 4	850		850 to 890	830 to 860	840 to 870			
42 CrMo 4, 42 CrMoS 4			840 to 880	820 to 850	830 to 860			
50 CrMo 4			840 to 880	820 to 850	830 to 860			
36 CrNiMo 4	850	650 to 700	850 to 880	820 to 850	830 to 860	540 to 680		
34 CrNiMo 6			850 to 880	—	830 to 860			
30 CrNiMo 8			850 to 880	—	830 to 860			
50 CrV 4	850	680 to 720	840 to 880	820 to 850	830 to 860	540 to 680		
30 CrMoV 9			860 to 900	840 to 870	850 to 880			

1) End quench test in the case of unalloyed steels only for the high-grade steels (Ck and Cm steels and 28 Mn 6 steel).
2) Quenching medium to be selected according to the shape and dimensions of the workpiece.
3) Cooling in air.

Table 13. Table showing minimum yield strength values of material in the quenched and tempered condition For the steels listed in the same box, in each case the minimum yield strength immediately under them indicated by a bold line shall apply.

	30 CrNiMo 8 30 CrMoV 9	30 CrNiMo 8		
	34 CrNiMo 6	30 CrMoV 9		
	42 CrMo (S) 4 50 CrMo 4 36 CrNiMo 4 50 CrV 4	34 CrNiMo 6	30 CrNiMo 8 30 CrMoV 9	
	41 Cr (S) 4 34 CrMo (S) 4	36 CrNiMo 4 50 CrV 4	34 CrNiMo 6	30 CrNiMo 8 30 CrMoV 9
	37 Cr (S) 4	50 CrMo 4 42 CrMo (S) 4		
	34 Cr (S) 4 25 CrMo (S) 4		50 CrMo 4 36 CrNiMo 4 50 CrV 4	34 CrNiMo 6 30 CrNiMo 8 30 CrMoV 9
	46 Cr (S) 2 28 Cr (S) 4	41 Cr (S) 4 34 CrMo(S) 4 37 Cr (S) 4 25 CrMo (S) 4	42 CrMo (S) 4	50 CrMo 4 50 CrV 4 36 CrNiMo 4 34 CrNiMo 6 50 CrMo 4 36 CrNiMo 4
	28 Mn 6 C 50, Ck 50, Cm 50	34 Cr (S) 4		34 CrNiMo 6 50 CrV 4
	C 55, Ck 55, Cm 55 38 Cr (S) 2	46 Cr (S) 2 28 Cr (S) 4	41 Cr (S) 4 34 CrMo(S) 4	50 CrMo 4 36 CrNiMo 4
	C 50, Ck 50, Cm 50 C 45, Ck 45, Cm 45	C 60, Ck 60, Cm 60 C 55, Ck 55, Cm 55	37 Cr (S) 4	34 CrMo (S) 4 42 CrMo (S) 4
	C 40, Ck 40, Cm 40 32 Cr (S) 2	C 50, Ck 50, Cm 50 38 Cr (S) 2	34 Cr (S) 4	25 CrMo (S) 4 34 CrMo (S) 4
	C 35, Ck 35, Cm 35	C 45, Ck 45, Cm 45	25 CrMo(S) 4 / C 60, Ck 60, Cm 60 28 Mn 6 C 55, Ck 55, Cm 55	34 CrMo (S) 4
	C 30, Ck 30, Cm 30	C 40, Ck 40, Cm 40	28 Cr (S) 4 46 Cr (S) 2 / C 50, Ck 50, Cm 50	25 CrMo (S) 4
	C 25, Ck 25, Cm 25 C 22, Ck 22, Cm 22	C 35, Ck 35, Cm 35 C 30, Ck 30, Cm 30 32 Cr (S) 2	C 45, Ck 45, Cm 45 C 40, Ck 40, Cm 40 38 Cr (S) 2	
		C 25, Ck 25, Cm 25 C 22, Ck 22, Cm 22	C 35, Ck 35, Cm 35 C 30, Ck 30, Cm 30 ¹⁾ 32 Cr (S) 2	
	$d \leq 16$	$16 < d \leq 40$	$40 < d \leq 100$	$100 < d \leq 160$
				$160 < d \leq 250$
	Diameter range, in mm			
	1) For diameters over 40 up to 63 mm.			

Note. (S) in this table means that the value applies to both the steel grade with a maximum sulfur content and to that with a controlled sulfur content.
 Example: symbol 38 Cr (S) 2 identifies both 38 Cr 2 steel and 38 CrS 2 steel.

Appendix A

Equivalent diameter for the mechanical properties

A.1 Concept

The ruling section of a product is the cross section to which the values specified for the mechanical properties refer. Irrespective of the actual shape and dimensions of the product, the size of the ruling section is always expressed as a diameter ("equivalent diameter"). This diameter is that of an "equivalent round steel bar". This means a round bar which, at the position in the cross section specified for taking the test pieces for mechanical testing, on cooling from the austenitizing temperature, has a cooling rate equivalent to that of the ruling section of the product concerned at the location specified for sampling.

A.2 Determining the equivalent diameter

A.2.1 In the case of round steel, the equivalent diameter is equal to the nominal diameter of the product.

A.2.2 In the case of hexagonal and octagonal steel, the equivalent diameter is equal to the nominal distance between two opposite parallel sides.

A.2.3 In the case of square steel and flat steel, the equivalent diameter shall be determined as shown in the example in figure A.1.

In the case of forgings, the equivalent diameter shall be determined as described in figure A.2.

A.2.4 ● For all other product forms, the equivalent diameter shall be agreed.

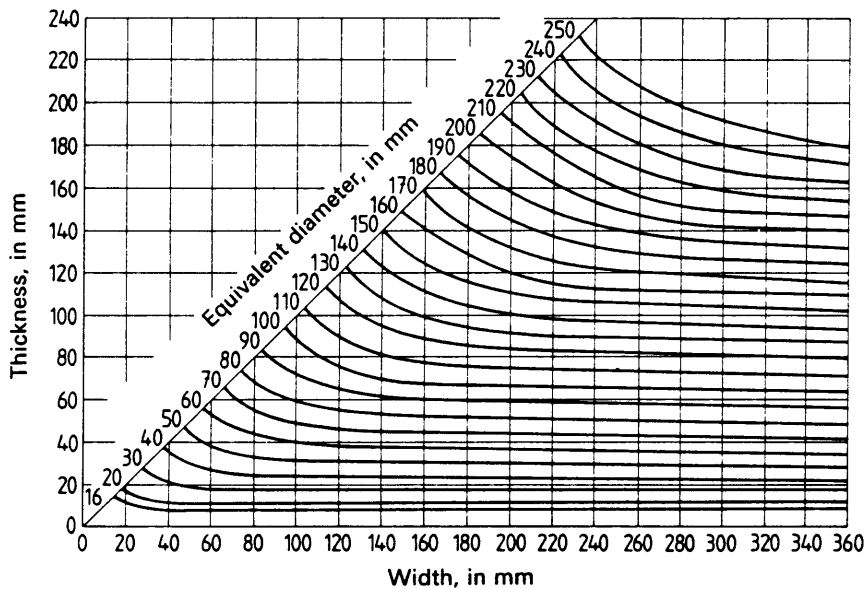

Figure A.1. Determination of the equivalent diameter for square and rectangular steel bars on the basis of the values specified for round steel bars in the quenched and tempered condition

Example: for a flat steel of 40 mm × 60 mm in size, the equivalent diameter is 50 mm.

The following shall apply for determining the equivalent diameter (d):	
	<p>a) in the case of compact solid parts (for example, circular discs without holes) and in the case of similar pieces with holes (with an inside diameter of the hole of up to 200 mm), 1,5 times the smallest side length, i.e. $d = a \times 1,5$;</p>
	<p>b) in the case of rings (with an inside diameter of more than 200 mm), 1,5 times the thickness, if $\frac{D_1 - D_2}{2} < a$, or $d = a \times 1,5$, if $\frac{D_1 - D_2}{2} > a$;</p>
<p>c) in the case of open cylindrical hollow parts</p> 	<p>twice the wall thickness, if the inside diameter is less than 80 mm: $d = \frac{D_1 - D_2}{2} \times 2$ 1,75 times the wall thickness if the inside diameter is between 80 and 200 mm: $d = \frac{D_1 - D_2}{2} \times 1,75$ 1,5 times the wall thickness if the inside diameter is greater than 200 mm: $d = \frac{D_1 - D_2}{2} \times 1,5$</p>
<p>d) in the case of cylindrical hollow parts closed at one end or at both ends</p> 	<p>2,5 times the wall thickness if the inside diameter is smaller than 800 mm: $d = \frac{D_1 - D_2}{2} \times 2,5$ but d shall not exceed D_1; the multiplication factor shall be agreed if the inside diameter exceeds 800 mm.</p>
<p>e) in the case of non-cylindrical symmetrical hollow parts, the equivalent diameter shall be determined as appropriate on the basis of item c or d above.</p>	

Figure A.2. Equivalent diameters in the case of forgings

Appendix B

Dimensional standards relating to products covered by this standard

Hot rolled wire

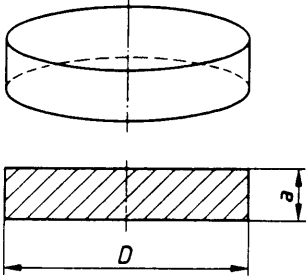
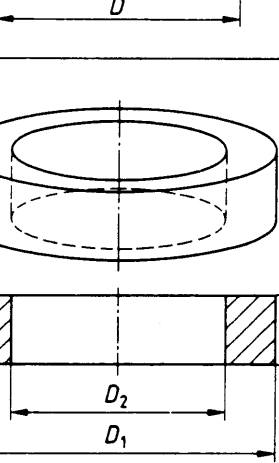
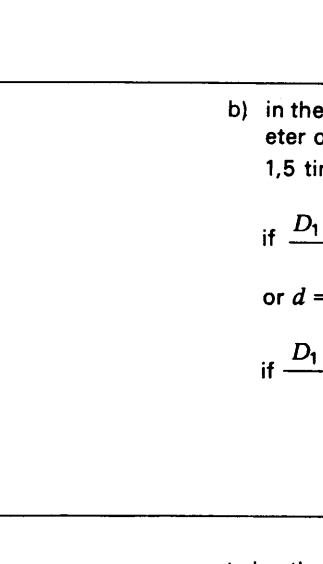
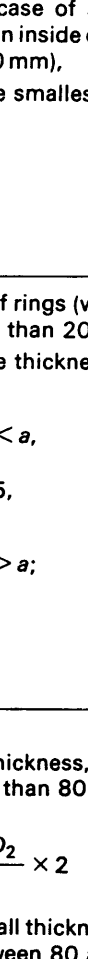
- DIN 59 110 Steel wire rod; dimensions, permissible deviations, masses
DIN 59 115 Steel wire rod for bolts, nuts and rivets; dimensions, permissible deviations, masses

Hot rolled and forged bars

- DIN 1013 Part 1 Steel bars; hot rolled round steel for general purposes; dimensions, permissible dimensional deviations and deviations of form
DIN 1013 Part 2 Steel bars; hot rolled round steel for special purposes; dimensions, permissible dimensional deviations and deviations of form
DIN 1014 Part 1 Steel bars; hot rolled squares for general purposes; dimensions, permissible dimensional deviations and deviations of form
DIN 1014 Part 2 Steel bars; hot rolled squares for special purposes; dimensions, permissible dimensional deviations and deviations of form
DIN 1015 Steel bars; hot rolled hexagons; dimensions, masses, permissible deviations
DIN 1017 Part 1 Steel bars; hot rolled flats for general purposes; dimensions, masses, permissible deviations
DIN 1017 Part 2 Steel bars; hot rolled flats for special applications (in bar drawing shops, screw works, etc.); dimensions, masses, permissible deviations
DIN 7527 Part 6 Steel forgings; machining allowances and permissible deviations for hammer forged bars
DIN 59 130 Steel bars; hot rolled round steel for bolts and rivets; dimensions, permissible dimensional deviations and deviations of form

Cold rolled flat products

- DIN 1544 Steel flat products; cold rolled steel strip; dimensions, permissible dimensional deviations and deviations of form

Hot rolled plate, sheet, strip and hot rolled wide flats

- DIN 1016 Steel flat products; hot rolled strip, hot rolled sheet under 3 mm thickness; dimensions, permissible dimensional deviations, deviations of form and in mass
DIN 1543 Steel flat products; hot rolled plate 3 to 150 mm thick; permissible dimensional deviations, deviations of form and in mass
DIN 59 200 Steel flat products; hot rolled wide flats; dimensions, permissible dimensional deviations, deviations of form and in mass

Forgings

- DIN 2519 Steel flanges; technical delivery conditions
DIN 7526 Steel forgings; tolerances and permissible deviations for drop forgings
Supplement to
DIN 7526 Steel forgings; tolerances and permissible deviations for drop forgings; examples of application
DIN 7527 Part 1 Steel forgings; machining allowances and permissible deviations for hammer forged discs
DIN 7527 Part 2 Steel forgings; machining allowances and permissible deviations for hammer forged pierced discs
DIN 7527 Part 3 Steel forgings; machining allowances and permissible deviations for seamless hammer forged rings
DIN 7527 Part 4 Steel forgings; machining allowances and permissible deviations for seamless hammer forged bushes
DIN 7527 Part 5 Steel forgings; machining allowances and permissible deviations for hammer forged, rolled and welded rings
DIN 7527 Part 6 Steel forgings; machining allowances and permissible deviations for hammer forged bars

Standards and other documents referred to

- DIN 1599 Identification markings for steel
- DIN 1654 Part 4 Steels for cold heading and cold extruding; technical delivery conditions for steels for quenching and tempering
- DIN 8528 Part 1 Weldability; metallic materials, concepts
- DIN 17 010 General technical delivery conditions for steel and steel products
- DIN 17 014 Part 1 Heat treatment of ferrous materials; terminology
- DIN 50 049 Materials testing certificates
- DIN 50 103 Part 1 Testing of metallic materials; Rockwell hardness tests; C, A, B, F scales
- DIN 50 115 Testing of metallic materials; impact test
- DIN 50 125 Testing of metallic materials; tensile test pieces
- DIN 50 145 Testing of metallic materials; tensile test
- DIN 50 191 Testing of ferrous materials; end quench test; test piece length: 100 mm, test piece diameter: 25 mm
- DIN 50 192 Determination of decarburization depth
- DIN 50 351 Testing of metallic materials; Brinell hardness test
- DIN 50 601 Metallographic examination; determination of the ferritic or austenitic grain size of steel and ferrous materials
- DIN 50 602 Metallographic examination; microscopic examination of special steels using standard diagrams to assess the content of non-metallic inclusions
- EURONORM 18 Selection and preparation of samples and test pieces for steel and iron and steel products
- EURONORM 20 Definitions and classification of steel grades
- EURONORM 79 Terminology and classification of steel products by shapes and sizes
- Stahl-Eisen-Lieferbedingungen 055**) (at present at the stage of draft) *Warmgewalzter Stabstahl und Walzdraht mit rundem Querschnitt und nicht profilierter Oberfläche; Oberflächengüteklassen; technische Lieferbedingungen* (Hot rolled steel bars and rods of circular cross section and non-profiled surface; surface quality classes; technical delivery conditions)
- Stahl-Eisen-Lieferbedingungen 071**) *Oberflächenbeschaffenheit von warmgewalztem Grob- und Mittelblech sowie Breitflachstahl* (Surface quality of hot rolled heavy and medium plate and wide flats)
- Stahl-Eisen-Prüfblatt 1805**) *Probenahme und Probenvorbereitung für die Stückanalyse bei Stählen* (Sampling and sample preparation for the product analysis of steels)
- Handbuch für das Eisenhüttenlaboratorium**) (Handbook for the ferrous metallurgy laboratory);
 volume 2: *Die Untersuchung der metallischen Werkstoffe*
 (Investigation of metallic materials), Düsseldorf 1966;
 volume 5 (supplement):
 A 4.4 – *Aufstellung empfohlener Schiedsverfahren*
 (List of recommended arbitration procedures);
 B – *Probenahmeverfahren* (Sampling methods);
 C – *Analysenverfahren* (Methods of analysis);
 latest edition in each case.
- DIN-Normenheft 3*) *Kurznamen und Werkstoffnummern der Eisenwerkstoffe in DIN-Normen und Stahl-Eisen-Werkstoffblättern* (Symbols and material numbers for ferrous materials dealt with in DIN Standards and Iron and steel material sheets)

See Appendix B for other standards referred to.

*) Verlag Stahleisen mbH, Postfach 82 29, D-4000 Düsseldorf 1.

Other relevant standards and documents

DIN 1651	Free cutting steels; technical delivery conditions
DIN 1654 Part 1	Steels for cold heading and cold extruding; technical delivery conditions; general
DIN 17 115	Steels for welded round link chains; technical delivery conditions
DIN 17 140 Part 1	Wire rod for cold drawing; technical delivery conditions for basic steel and unalloyed quality steels
DIN 17 211	Nitriding steels; technical delivery conditions
DIN 17 212	Flame and induction hardening steels; quality specifications
DIN 17 221	Hot rolled steels for springs suitable for quenching and tempering; quality specifications
DIN 17 222	Cold rolled steel strip for springs; technical delivery conditions
DIN 17 223 Part 2	Round steel wire for springs; quality specifications; quenched and tempered spring wire and quenched and tempered valve spring wire made from unalloyed steels
DIN 17 230	Ball and roller bearing steels; technical delivery conditions
DIN 17 240	Heat-resisting and highly heat-resisting materials for bolts and nuts; quality specifications
DIN 17 280	Steels with low temperature toughness; technical delivery conditions for strip, plate, sheet, wide flats, steel sections, steel bars and forgings

Stahl-Eisen-Werkstoffblatt 550 *) (Iron and steel material sheet) *Stähle für größere Schmiedestücke* (Steels for larger forgings)

Previous editions

DIN 1661: 09.24, 06.29; DIN 1662: 07.28, 06.30; DIN 1662 Supplement 5, Supplement 6, Supplements 8 to 11: 05.32; DIN 1663: 05.36, 12.39x; DIN 1663 Supplement 5, Supplements 7 to 9: 02.37x; DIN 1665: 05.41; DIN 1667: 11.43; DIN 17 200 Supplement: 05.52; DIN 17 200: 12.51, 12.69, 11.84.

Amendments

The following amendments have been made in comparison with the November 1984 edition.

- The specifications dealing with mechanical properties of products in the normalized condition and laid down in the November 1984 edition shall only apply to flat products. The mechanical properties of long products in the normalized condition previously specified in the December 1969 edition, table 9, have been reintroduced in the present edition, after conversion of the values into the N/mm² unit. (See also the relevant article in *DIN-Mitteilungen* (DIN News) No. 10, 1985.)
- The information given in table 11, No. 3, column 5, as to where the hardness of the products in the "treated for shearability" or "softened" condition is to be tested, has been specified in more detail.
- The indication "quenching in oil" is no longer given in figure A.1. The title of figure A.1 has been amended accordingly.
- In figure A.2, item d), in contrast to the previous specification (d = outside diameter D_1), the formula for the determination of the equivalent diameter, d , shall not only apply to cylindrical hollow parts closed at one end, but also to those closed at both ends (i.e., $D = 2,5$ times the wall thickness).
- Subclause 7.5 has been revised editorially.

The following amendments have been made in comparison with the December 1969 edition.

- In this edition of the standard, no information has been given as to the temperature of use of the products.
- This standard applies not only to hot rolled but also to cold rolled plate, sheet and strip. Seamless tubes are no longer covered (see Explanatory notes).
- The distinction between high-grade steels and quality steels has been changed on the basis of EURONORM 20–74.
- For the various treatment conditions, only code letters have been given, because the corresponding appended numbers are not generally used outside the civil aviation industry.
- 40Mn 4 and 32CrMo12 steels have been deleted (see Explanatory notes).
- Cm 22, C 25, Ck 25, Cm 25, C 30, Ck 30, Cm 30, C 40, Ck 40, Cm 40, C 50, Ck 50, Cm 50, 32Cr 2, 32CrS 2, 38CrS 2, 46CrS 2, 28Cr 4, 28CrS 4 and 25CrMoS 4 steels have been adopted for the first time.
- The carbon content in C 22 and Ck 22 steels has been reduced to 0,17 to 0,24 % by mass. The carbon content in 38Cr 2 steel has been changed to 0,35 to 0,42 % by mass. For 30CrNiMo 8 steel, the upper limit of the carbon content has been raised to 0,34 % by mass.
- The maximum silicon content has in all cases been specified as 0,40 % by mass.
- The maximum sulfur content in high-grade steels, for which only a maximum content is specified, has been changed to 0,03 % by mass (see Explanatory notes).
- For quality steels, a footnote has been adopted stating that they can also be ordered with a lead content of 0,15 to 0,30 % by mass.

*) See page 35.

- l) It is permitted to exceed slightly the limiting values specified for the cast analysis only in those cases where, either restricted hardenability scatterbands or supply of quenched and tempered or normalized products is required and where the mechanical properties specified for the quenched and tempered or normalized condition have been met. Subject to this condition, except in the case of phosphorus and sulfur, it is permitted to exceed the limiting values specified for the cast analysis by the amount of the permissible deviations specified for the product analysis.
- m) The previous system of forms of supply (requirement classes) has been discarded (see Explanatory notes).
- n) The conditions "heat treated to reach a particular tensile strength (BF)" and "heat treated for improved workability (B)" have been discarded. The condition "cold shearable (C)" has been changed to "treated for shearability (C)".
- o) Following reexamination of the previous specifications, adherence to the hardenability scatterbands specified for most alloy steels have now been made mandatory (see Explanatory notes).
- p) The restricted hardenability scatterbands of alloy steels and of 28 Mn 6 steel are shown on a graph (see Explanatory notes).
- q) This standard gives guideline values for the hardenability scatterbands of unalloyed high-grade steels with a minimum carbon content of not less than 0,32 % (see Explanatory notes).
- r) For high-grade steels, the maximum permissible content of oxidic non-metallic inclusions has been specified (see Explanatory notes).
- s) The specifications for the mechanical properties of normalized products have been extended to cover diameters or thicknesses up to 160 mm.
- t) The hot shaping temperatures have been deleted.
- u) In the case of steel bars of round, square or rectangular cross section and a diameter or thickness of over 25 up to 100 mm, the tensile test pieces and impact test pieces are to be taken so that their centre line is 12,5 mm below the surface of the product. In addition, diagrams have been included showing the location of test piece to be taken from flat products.
- v) The figure showing the applicability of the values specified for circular cross sections for the quenched and tempered state to square and rectangular cross sections has been replaced by a new diagram applicable to quenching in oil.
- w) The equivalent diameter for the mechanical properties has been defined in an appendix.

Explanatory notes

As already reported in detail in *DIN-Mitteilungen* No. 10, 1985, a number of users in industry, who did not take part in the discussions leading to the publication of the revised edition of this standard in November 1984, subsequently discovered serious disadvantages in the application of the minimum yield strength values, specified in ISO 683 Part 18 for normalized unalloyed steels, which had been unanimously adopted by the committee for inclusion in the revised standard on the basis of statistical data from tests on plate and sheet. This is the reason for the withdrawal of the amendments introduced in the November 1984 edition, as set out under a) in the "Amendments" clause above. As soon as sufficient test data are also available for long products, the values given in table 8 are to be checked against the mechanical properties actually to be expected for steels produced by modern methods, which do not use admixtures of scrap to any great extent. The minimum tensile strength values which are now found to lie below, sometimes far below, those specified in ISO 683 Part 18 are also due to be checked as soon as possible by means of statistical evaluations.

The Explanatory notes of the November 1984 edition still seem pertinent and have thus been reprinted here, unchanged except for those alterations made necessary by the publication of ISO/DIS 683 Part 1.

The pipe manufacturers requested that pipes made from quenched and tempered steels were to be covered in a separate standard. The reasons for this request were:

that not all steels specified in this standard are to be used for tubes and, on the other hand, some quenched and tempered steels used for tubes are not covered by this standard;

that there are a number of specifications that are specific to tubes (for example, test methods);

that in this manner, the number of footnotes could be reduced and hence the layout of the standard made more suitable for data processing and

that revision of the standard would be facilitated.

Of the manganese alloyed steels only grade 28 Mn 6 has been retained. The steel manufacturers would have preferred to exclude manganese steels from standardization completely although such steels are used to a certain extent. The reason for this request for deletion was that the use of such steels was very restricted because of their tendency to segregation and their resulting wide hardenability scatterbands in comparison with chromium alloy steels. The users, on the other hand, even proposed, mainly for cost reasons, a series covering 5 Mn 6 to 50 Mn 6 steels (continuous series of carbon steels).

32 CrMo 12 steel has been deleted because in practice it has been replaced by 30 CrMoV 9 steel.

As a compromise between the various ideas regarding the maximum sulfur content of those high-grade steels, for which no minimum value is specified, a value of 0,03% max. should be assumed. In particular, representatives of the mechanical engineering and screw-making industry would have preferred a maximum content between 0,015 and 0,025%. On the other hand, some representatives of the motorcar industry would have preferred a maximum sulfur content of 0,035 or 0,040% to improve machinability, but in conjunction with a reduction in the maximum permissible phosphorus content to 0,025%. The steel manufacturers pointed out that the production quantity for a grade containing a maximum of 0,020% sulfur, for example, is small and that it would therefore not justify a standardization of such a steel. Apart from this, with regard to the upper limit they would have preferred a widest possible overlap with those grades having a controlled sulfur

content, because about 80% of supplies for the motorcar industry consisted of grades with a controlled sulfur content. The steel manufacturers declared that the maximum phosphorus content should be left at 0,035%, because such a content would cause no problems and some casts exhibit in any case a phosphorus content exceeding 0,025%. For the revised editions of an ISO Standard for quenched and tempered steels and of EURONORM 83, a maximum content of 0,035% each for phosphorus and sulfur is being proposed for this group of steels.

Apart from this, the motorcar manufacturers proposed that, in the case of quality steels and high-grade steels, grades with a sulfur content of 0,020 to 0,045% and 0,020 to 0,035% respectively should be specified as the standard qualities and grades with higher controlled sulfur contents, or only a maximum sulfur content should be referred to in a footnote as special quality grades; this proposal was not supported by the representatives of the other interested parties. It was pointed out that new specifications along these lines would not be acceptable particularly for flat products and for heavy forgings.

For the high-grade steels with controlled sulfur content, a range of 0,020 to 0,040% is being proposed for the revised editions of an ISO Standard and of EURONORM 83, whilst the range specified in this standard is 0,020 to 0,035%. The upper limit of 0,035% was regarded in the German discussions as a good compromise between the requirements for toughness and machinability; raising the upper limit to 0,040% would hardly be likely to improve the machinability. As regards the lower limit of 0,020%, some representatives of the motorcar industry were afraid that with sulfur contents of 0,015% in the product, as would be possible on the basis of the deviations permitted for the product analysis, machinability could be impaired. The steel manufacturers observed on this point that it would be necessary then to raise the value of sulfur content for the cast analysis to 0,025 up to 0,040% which would have an adverse effect on the toughness values.

It was decided to defer the standardization of steels for quenching and tempering with sulfur contents of 0,06 to 0,09% or even 0,08 to 0,12%, as in some cases requested by the motorcar industry. This point is to be considered again during the revision work on the standard for free cutting steels (DIN 1651).

With regard to the wish of consumers to narrow the ranges for the carbon content of unalloyed steels, the steel manufacturers pointed out that, at least in the case of high-grade steels, a restriction of the carbon range could be achieved by restricting the hardenability scatterband. Moreover, as a result of the overlap areas in the carbon ranges, there was a greater possibility of meeting the wishes of the various customers and of reducing the risk with regard to steel-making.

Since the system of forms of supply for characterizing the desired requirements, as specified in DIN 17 200, December 1969 edition, was hardly used in practice, it has been omitted from this revised edition of the standard and, after detailed discussions on the various details, it has been replaced by the normal combinations of heat treatment conditions of the material on delivery, product forms and requirements given in table 1. This means that there is now a clear statement as to which requirements have to be complied with for which heat treatment condition, if no relevant information is given in the order.

The hardenability scatterbands of alloy steels have been checked on the basis of large scale evaluations by the steel manufacturers; on this basis it was possible to standardize the hardenability scatterbands, which had previously been provisional, for most alloy steels, in some cases with some

changes, as binding values. The most important changes to the lower limit of the scatterband have been made in the case of 41 Cr 4, 41 CrS 4, 42 CrMo 4 and 42 CrMoS 4 steels; these corrections were made on the basis of the manufacturing conditions of steel production.

It should be noted, that the values specified in table 4 are based on an evaluation of cast analyses and that there may be some variations in comparison with the cast analysis in the case of a subsequent test on the product. In order to be able, at a later date, to give some quantitative information on the extent of the deviations, manufacturers and users have been requested to collect data on this point. The users were of the opinion that the values given in table 4 should also apply to product analyses.

The steel manufacturers stated that their results regarding hardenability values were essentially based on tests on separately cast test bars which could be regarded as representative of the relevant cast with regard to the chemical composition and hence also the hardenability. The end quench test pieces would be taken from these low-segregation test bars after forging down to about 30 mm diameter. If the values are to apply to product tests also, it would also be necessary to take into account the accuracy of the test and the inhomogeneity within the casts, which would mean widening the scatterbands given in table 4; on the basis of a foreign test it was found that there is a dispersion of test results of ± 2 HRC even for a single bar. The users pointed out that from their point of view, for acceptance inspection, only a product test was possible. Since the cast analyses evaluated by the steel manufacturers covered numerous casts and various manufacturers and hence included virtually all possible combinations of chemical composition, the possible inhomogeneities in the cast would already have been taken into account so that the values given in table 4 should remain valid for product tests also. Within a cast a certain dispersion of the hardness values would be acceptable but the values would in any case have to be within the limits specified in table 4.

Since the lower limiting curves for the hardenability scatterbands of 41 Cr 4, 41 CrS 4, 42 CrMo 4 and 42 CrMoS 4 steels had been lowered, although users wanted to retain the previous narrower ranges by restricting the scatterband with respect to the upper or lower limiting curve, it is no longer possible to talk in general terms of a $\frac{2}{3}$ restriction of the scatterband. The restricted hardenability scatterbands of alloy steels and 28 Mn 6 steel, applicability of which has to be specially agreed, have therefore been represented graphically.

The limiting curves of the restricted hardenability scatterbands of 28 Mn 6, 32 Cr 2, 32 CrS 2, 38 Cr 2, 38 CrS 2, 46 Cr 2, 46 CrS 2, 28 Cr 4, 28 CrS 4, 34 Cr 4, 34 CrS 4, 37 Cr 4, 37 CrS 4, 25 CrMo 4 and 25 CrMoS 4 steels have been extended beyond the distance from the quenched end at which the lower limiting curve of the unrestricted scatterband reaches the lowest hardness value (21 or 20 HRC). These extended limiting curves are not based on evaluations but were derived from the following schematic procedure.

For restriction with respect to the upper limiting curve of the unrestricted hardenability scatterband, the hardness range obtained at the intersection of the lower limiting curve

the restricted scatterband with the lowest hardness value represented was adopted; the upper limiting curve in the case of restriction with respect to the lower limiting curve of the unrestricted scatterband was similarly continued parallel to the upper limiting curve of the complete range of hardenability in the ratio existing at that "intersection". These "constructed" limiting curves cannot therefore be binding and should only be regarded as a rough guide when material is ordered.

In this standard, provisional values for hardenability scatterbands for unalloyed high-grade steels with a lower limit of carbon content of not less than 0,32 % have been adopted. In order to obtain adequate differentiation and reproducibility of values, the measurement is made at intervals of 1 mm each up to a distance of 11 mm from the quenched end; it should be noted that at these intervals between the test indentations and at hardness values of less than 30 HRC, there is mutual interaction between the test indentations. In order to derive the values, the steel manufacturers, taking into account all current steelmaking processes, evaluated the data from about 150 casts of each of steel grades Ck 35, Ck 45 and Ck 55 and determined the relevant values for steel grades Ck 40, Ck 50 and Ck 60 by interpolation or extrapolation. For unalloyed steels, there is provision for a possible restriction of the hardenability scatterbands only for one or at the most two distances from the quenched ends. The values to be complied with in this case are shown in tabular form.

The quantitative values adopted in this standard for the oxidative degree of cleanness of high-grade steels are based on large-scale evaluations. It should be noted that the specifications in table 10 are limited in terms of dimensions and cannot be extrapolated to the complete field of application of this standard.

There was, in principle, agreement that it would be reasonable to create surface quality classes for the requirements regarding surface quality (permissible depths of cracks). However, since there was no clear idea as to the values to be specified and it was desired not to hold up the revision of this standard, it was deemed reasonable not to give any concrete values for this, but to prepare product-related *Stahl-Eisen-Lieferbedingungen* (Iron and Steel delivery conditions) and to make reference to these, as had already been done in this standard in the case of round steel bars and rods and for flat products. The same procedure is to be adopted for the international standards.

In the same way as for the permissible depths of crack, it is intended also to specify permissible depths of skin decarburization.

This standard is related to the following international documents:

ISO 683 Part 1, Heat-treatable steels, alloy steels and free-cutting steels. Direct-hardening unalloyed and low-alloyed wrought steel in form of different black products.

EURONORM 83-70, Quenched and tempered steels; quality specifications.

In the following table, the steels specified in DIN 17 200 are compared with those specified in EURONORM 83 and ISO 683 Part 1.

Comparison of steels for quenching and tempering as specified in this standard with those specified in EURONORM 83-70 and ISO 683 Part 1

Steels for quenching and tempering as specified in					
DIN 17 200		EURONORM 83-70		ISO 683 Part 1	
Symbol	Material number	Symbol	1)	Symbol	1)
C 22 Ck 22 Cm 22	1.0402 1.1151 1.1149	— — —		— — —	
C 25 Ck 25 Cm 25 —	1.0406 1.1158 1.1163	1 C 25 2 C 25 3 C 25 —	● ● ●	C 25 C 25 E4 C 25 M2	● ● ●
C 30 Ck 30 Cm 30 —	1.0528 1.1178 1.1179	— — — —		C 30 C 30 E4 C 30 M2	● ● ●
C 35 Ck 35 Cm 35 —	1.0501 1.1181 1.1180	1 C 35 2 C 35 3 C 35 —	● ● ●	C 35 C 35 E4 C 35 M2	● ● ●
C 40 Ck 40 Cm 40 —	1.0511 1.1186 1.1189	— — — —		C 40 C 40 E4 C 40 M2	● ● ●
C 45 Ck 45 Cm 45 —	1.0503 1.1191 1.1201	1 C 45 2 C 45 3 C 45 —	● ● ●	C 45 C 45 E4 C 45 M2	● ● ●
C 50 Ck 50 Cm 50 —	1.0540 1.1206 1.1241	— — — —		C 50 C 50 E4 C 50 M2	● ● ●
C 55 Ck 55 Cm 55 —	1.0535 1.1203 1.1209	1 C 55 2 C 55 3 C 55 —	● ● ●	C 55 C 55 E4 C 55 M2	● ● ●
C 60 Ck 60 Cm 60 —	1.0601 1.1221 1.1223	1 C 60 2 C 60 3 C 60 —	● ● ●	C 60 C 60 E4 C 60 M2	● ● ●
28 Mn 6	1.1170	28 Mn 6	●	28 Mn 6	●
— — —		— — —		22 Mn 6 36 Mn 6 42 Mn 6	
32 Cr 2 32 CrS 2	1.7020 1.7021	— —		— —	
38 Cr 2 38 CrS 2	1.7003 1.7023	38 Cr 2 —	○	— —	

1) See page 41.

Comparison of steels for quenching and tempering as specified in this standard with those specified in EURONORM 83-70 and ISO 683 Part 1
(continued)

Steels for quenching and tempering as specified in					
DIN 17 200		EURONORM 83-70		ISO 683 Part 1	
Symbol	Material number	Symbol	1)	Symbol	1)
46 Cr 2 46 CrS 2	1.7006 1.7025	46 Cr 2 —	●	— —	
28 Cr 4 28 CrS 4	1.7030 1.7036	— —		— —	
34 Cr 4 34 CrS 4	1.7033 1.7037	34 Cr 4 —	●	34 Cr 4 34 CrS 4	● ●
37 Cr 4 37 CrS 4	1.7034 1.7038	37 Cr 4 —	●	37 Cr 4 37 CrS 4	● ●
41 Cr 4 41 CrS 4	1.7035 1.7039	41 Cr 4 —	●	41 Cr 4 41 CrS 4	● ●
25 CrMo 4 — 25 CrMoS 4	1.7218 1.7213	A 25 CrMo 4 B 25 CrMo 4 —	○	25 CrMo 4 — 25 CrMoS 4	● ●
34 CrMo 4 34 CrMoS 4	1.7220 1.7226	34 CrMo 4 —	○	34 CrMo 4 34 CrMoS 4	● ●
42 CrMo 4 42 CrMoS 4	1.7225 1.7227	42 CrMo 4 —	○	42 CrMo 4 42 CrMoS 4	● ●
50 CrMo 4 —	1.7228	— 32 CrMo 12		50 CrMo 4 —	●
— —		40 NiCrMo 2 —		41 CrNiMo 2 41 CrNiMoS 2	
—		39 NiCrMo 3		—	
36 CrNiMo 4 34 CrNiMo 6	1.6511 1.6582	— 35 CrNiMo 6		36 CrNiMo 4 36 CrNiMo 6	● ○
30 CrNiMo 8 —	1.6580	30 CrNiMo 8 34 NiCrMo 16	○	31 CrNiMo 8 —	○
50 CrV 4 30 CrMoV 9	1.8159 1.7707	50 CrV 4 —	●	51 CrV 4 —	○

1) This column indicates the degree of agreement with regard to the chemical composition of the steels as specified in this standard and those in the international standards. The symbols have the following meanings:
● slight differences, ○ significant differences.

International Patent Classification

C 22 C 38/04
G 01 N 33/20

